

JL INDUSTRIES

**ACCESS PANELS
AND FLOOR DOORS**



Division 08 31 00

**Access Doors and Frames
Floor Doors**

Division 08 31 13.53

**Security Access Doors
and Panels**

Division 08 31 16

Access Panels and Frames

ACTIVAR
INC.

www.activar.com

Construction Products Group



JL INDUSTRIES



AIR LOVERS



SAMSON PRODUCTS



THOMAS ENTERPRISES



HIAWATHA

INTERIOR ACCESS PANELS: FIRE-RATED



MODEL FDWB WITH WALLBOARD BEAD



MODEL FDPW WITH PLASTERGUARD

FIRE-RATED & INSULATED CONCEALED FRAME ACCESS PANELS: FD & FDPW Series

FDWB: Wallboard Bead (Wall or Ceiling):

Frame: 16 gauge with 1" drywall bead that can be taped for a smooth appearance.

Door: 2" thick, insulated 20 gauge steel with continuous hinge.

Finish: Gray powder coat primer.

Latch: Universal turn ring and key lock (U).

FDPW: Plaster (Wall or Ceiling):

Frame: 16 gauge with 3/4" plasterguard.

Door: 2" thick, insulated 20 gauge steel with continuous hinge.

Finish: Gray powder coat primer.

Latch: Universal turn ring and key lock (U).

Options: Custom Colors, Galvanized Finish, Mortise Slam Lock Prep (UM) or Mortise Slam Lock Installed (UMI), 3" Metal Lath for FDPW, Stainless FDWB.

See Optional Colors on Page 12.

Fire-Rating of FDWB & FDPW:

Wall Installation: 1-1/2 hour UL "B" label in a 2 hour fire barrier.
File # R13067-1. Maximum size 48" x 48"

Ceiling Installation: Warnock Hersey listed for ceiling installations with 3 hour non-combustible rating or 1 hour combustibility rating.
File # WHI-495-PSH-0163. Maximum size 24" x 36"

CSFM: This product has been approved by the California State Fire Marshall (CSFM) pursuant to Section 13144.1 of the California Health and Safety Code. See CSFM Listing No 3330-1223:101 for allowable values and/or conditions for use concerning material presented in this document. It is subject reexamination, revision and possible cancellation.

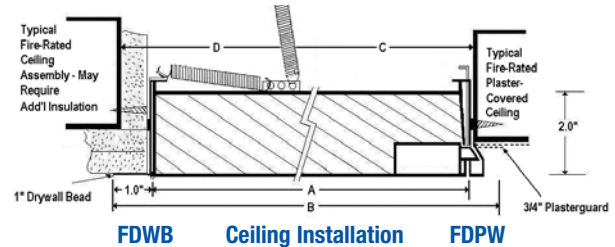
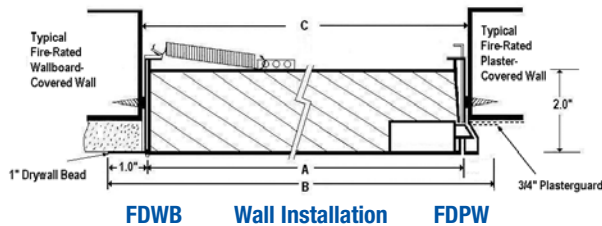

FD SERIES ACCESS PANELS - MODELS FD, FDSS, HGFD, FDWB & FDPW										
Model Size Width x Height	Outside Frame Dimensions		C-Wall Opening Dimensions		D-Opening Dimensions		Approximate Shipping Weight			Latch(es)
			1 1/2 Hour UL "B" Rated Wall		3-Hour Non-Combustible Ceiling					
	Width	Height	Width	Height	Width	Height	FD	FDSS	HGFD	
8" x 8"	10"	10"	8 3/8"	8 3/8"	9 5/8"	9 5/8"	6 lbs.	6 lbs.	11 lbs.	1
10" x 10"	12"	12"	10 3/8"	10 3/8"	11 5/8"	11 5/8"	8 lbs.	8 lbs.	15 lbs.	1
12" x 12"	14"	14"	12 3/8"	12 3/8"	13 5/8"	13 5/8"	10 lbs.	10 lbs.	17 lbs.	1
14" x 14"	16"	16"	14 3/8"	14 3/8"	15 5/8"	15 5/8"	12 lbs.	12 lbs.	22 lbs.	1
16" x 16"	18"	18"	16 3/8"	16 3/8"	17 5/8"	17 5/8"	15 lbs.	15 lbs.	24 lbs.	1
18" x 18"	20"	20"	18 3/8"	18 3/8"	19 5/8"	19 5/8"	17 lbs.	18 lbs.	30 lbs.	1
20" x 20"	22"	22"	20 3/8"	20 3/8"	21 5/8"	21 5/8"	21 lbs.	22 lbs.	51 lbs.	1
20" x 30"	22"	32"	20 3/8"	30 3/8"	21 5/8"	31 5/8"	28 lbs.	29 lbs.	53 lbs.	1
22" x 22"	24"	24"	22 3/8"	22 3/8"	23 5/8"	23 5/8"	26 lbs.	27 lbs.	51 lbs.	1
22" x 30"	24"	32"	22 3/8"	30 3/8"	23 5/8"	31 5/8"	29 lbs.	30 lbs.	53 lbs.	1
22" x 36"	24"	38"	22 3/8"	36 3/8"	23 5/8"	37 5/8"	36 lbs.	37 lbs.	58 lbs.	2
24" x 24"	26"	26"	24 3/8"	24 3/8"	25 5/8"	25 5/8"	27 lbs.	28 lbs.	47 lbs.	1
24" x 36"	26"	38"	24 3/8"	36 3/8"	25 5/8"	37 5/8"	37 lbs.	38 lbs.	60 lbs.	2
24" x 48"	26"	50"	24 3/8"	48 3/8"	-	-	54 lbs.	56 lbs.	85 lbs.	2
30" x 30"	32"	32"	30 3/8"	30 3/8"	-	-	38 lbs.	40 lbs.	62 lbs.	2
32" x 32"	34"	34"	32 3/8"	32 3/8"	-	-	43 lbs.	41 lbs.	81 lbs.	2
36" x 36"	38"	38"	36 3/8"	36 3/8"	-	-	52 lbs.	54 lbs.	92 lbs.	2
36" x 48"	38"	50"	36 3/8"	48 3/8"	-	-	61 lbs.	64 lbs.	114 lbs.	2

Custom Sizes and Modifications Available Upon Request



FIRE-RATED FLUSH ACCESS PANELS: FD Series

FD: Standard Panel (Wall or Ceiling):

Frame & Trim: 16 gauge steel with a 1" flange. Welded-on masonry anchor.

Door: 2" thick, insulated 20 gauge steel with continuous hinge.

Finish: Gray powder coat primer.

Latch: Universal turn ring and key lock (U).

FDSS: Stainless Steel (Wall or Ceiling):

Frame: 16 gauge stainless steel with 1" wall flange. Welded on masonry anchor.

Door: 2" thick, insulated 20 gauge stainless steel with continuous hinge.

Finish: 304 stainless steel - #4 satin finish.

Latch: Universal turn ring and key lock (U).

HGFD: Heavy Gauge and Security (Wall):

Frame: 14 gauge steel with 1" wall flange. Welded-on masonry anchor.

Door: 2" thick, insulated 14 gauge steel with continuous hinge.

Finish: Gray powder coat primer.

Latch: Universal turn ring and key lock (U).

Options: Custom Colors, Galvanized Finish, Mortise Slam Lock Prep (UM) or Mortise Slam Lock Installed (UMI). **See Optional Colors on Page 12.** See also non-rated security panels on page 8.



MODEL FD

Fire-Rating of FD, FDSS & HGFD:

Wall Installation: 1-1/2 hour UL "B" label in a 2 hour fire barrier.

File # R13067-1. Maximum size 48" x 48"

Ceiling Installation: Warnock Hersey listed for ceiling installations with 3 hour non-combustible rating or 1 hour combustibile rating.

File # WHI-495-PSH-0163. Maximum size 24" x 36"

CSFM: This product has been approved by the California State Fire Marshall (CSFM) pursuant to Section 13144.1 of the California Health and Safety Code. See CSFM Listing No 3330-1223:101 for allowable values and/or conditions for use concerning material presented in this document. It is subject reexamination, revision and possible cancellation.



UNIVERSAL TURN RING AND KEY LOCK INCLUDED



All Fire-Rated Models Shown in Chart at Left:

Most Sizes of Model FD In Stock at One of Our 7 US Warehouses for Next Day Shipping - See Stock List.

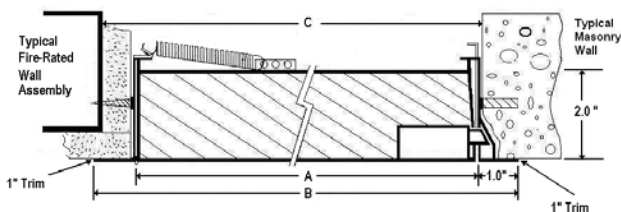

Wall Installation - FD-FDSS-HGFD Top View

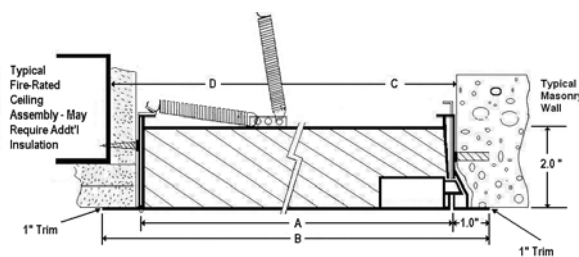

Ceiling Installation - FD-FDSS-HGFD Side View

Order Format
For Fire-Rated Models: **Style Code** - **Width** - **Height** - **Latch** - **Optional Color Code FD & HGFD (Pg 12)**
(U Standard, UM & UMI Optional)

Example: **HGFD-1212UMI-W**

INTERIOR ACCESS PANELS: FLUSH



MODEL TM



MODEL TMS STAINLESS STEEL

MULTI-PURPOSE FLUSH STEEL ACCESS PANEL:

TM and TMS Series

TM: Standard Panel (Wall or Ceiling)

Frame: 16 gauge steel with a 1" wall flange.

Door: 16 gauge steel access door mounted with mounted with 90° continuous, concealed hinge.

Finish: Gray powder coat primer.

Lock: Flush screwdriver-operated steel cam (C).

TMS: Standard Stainless Steel Panel (Wall or Ceiling)

Frame: 18 gauge stainless steel with 1" wall flange.

Door: 16 gauge stainless steel access door mounted with 90° continuous, concealed hinge.

Finish: 304 stainless - #4 satin finish.

Lock: Flush screwdriver-operated cam (C).

Options: Custom Colors, Double Door, Louvered Vents, Plexiglass View Window, Removeable Door (no hinge), Rainhood, Gasketing, Galvanized Finish (TMG), Cylinder Lock, Mortise Cam Latch, Mortise Deadbolt Lock, Mortise Slam Latch, Knob Cam, Torx, Spanner or Hex Head Cam.

See Optional Colors and Locks on Page 12.

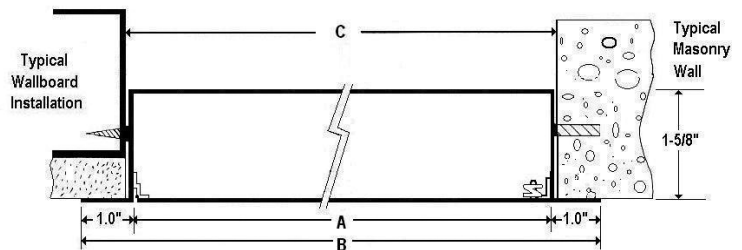

Model TM

Model TMS

22 Sizes of TM and 8 Sizes TMS In Stock at one of our 7 US Warehouses for Next Day Shipping - See Stock List.

Door Sizes and Wall/Ceiling Openings: Models TM and TMS													
Dimensions in Inches • Weight in Pounds													
A-Model Size Width x Height	B-Outside Frame Dimensions		C-Wall Opening Dimensions		Shipping Weight	Latch(es)	A-Model Size Width x Height	B-Outside Frame Dimensions		C-Wall Opening Dimensions		Approx. Shipping Weight	Latch(es)
	Width	Height	Width	Height				Width	Height	Width	Height		
6" x 6"	8"	8"	6 3/8"	6 3/8"	4 lbs.	1	18" x 18"	20"	20"	18 3/8"	18 3/8"	12 lbs.	3
8" x 8"	10"	10"	8 3/8"	8 3/8"	4 lbs.	1	20" x 24"	22"	26"	20 3/8"	24 3/8"	15 lbs.	4
8" x 12"	10"	14"	8 3/8"	12 3/8"	6 lbs.	1	20" x 30"	22"	32"	20 3/8"	30 3/8"	20 lbs.	4
10" x 10"	12"	12"	10 3/8"	10 3/8"	6 lbs.	1	22" x 22"	24"	24"	22 3/8"	22 3/8"	17 lbs.	4
12" x 12"	14"	14"	12 3/8"	12 3/8"	7 lbs.	1	22" x 30"	24"	32"	22 3/8"	30 3/8"	22 lbs.	4
12" x 16"	14"	18"	12 3/8"	16 3/8"	9 lbs.	1	22" x 36"	24"	38"	22 3/8"	36 3/8"	24 lbs.	5
12" x 18"	14"	20"	12 3/8"	18 3/8"	10 lbs.	1	24" x 24"	26"	26"	24 3/8"	24 3/8"	18 lbs.	4
12" x 24"	14"	26"	12 3/8"	24 3/8"	12 lbs.	2	24" x 30"	26"	32"	24 3/8"	30 3/8"	22 lbs.	5
14" x 14"	16"	16"	14 3/8"	14 3/8"	9 lbs.	1	24" x 36"	26"	38"	24 3/8"	36 3/8"	25 lbs.	5
16" x 16"	18"	18"	16 3/8"	16 3/8"	11 lbs.	1	30" x 30"	32"	32"	30 3/8"	30 3/8"	30 lbs.	5
16" x 20"	18"	22"	16 3/8"	20 3/8"	13 lbs.	2	36" x 36"	38"	38"	36 3/8"	36 3/8"	41 lbs.	5

Custom Sizes and Special Modifications Available Upon Request

Order Format

For Above Models: **Style Code** **Width** **Height** **Lock (C Standard or Optional)** **Optional TM Color**

Example: **TM-2424C-W**

INTERIOR ACCESS PANELS: CONCEALED FRAME



CONCEALED FRAME FLUSH ACCESS PANELS FOR DRYWALL OR PLASTER: WB, PW, and PWE, Series

WB: Wallboard Bead (Wall or Ceiling)

Frame: 16 gauge with 1" drywall bead that can be taped and mudded.
Door: 16 gauge steel with concealed continuous hinge.
Finish: Gray powder coat primer.
Lock: Flush screwdriver-operated cam (C).

PW: Plaster (Wall or Ceiling)

Frame: 16 gauge steel with 3/4" plasterguard for application of plaster.
Door: 16 gauge steel with concealed continuous hinge.
Finish: Gray powder coat primer.
Lock: Flush screwdriver-operated cam (C).

PWE: Plaster (Wall or Ceiling)

Frame: 16 gauge steel with 3/4" plasterguard with an additional 3" wide wing of metal lath for a plaster application to the edge of the door.
Door: 16 gauge steel with concealed continuous hinge.
Finish: Gray powder coat primer.
Lock: Flush screwdriver-operated cam (C).

Options: Cylinder Lock, Knob Cam, Torx, Spanner or Hex Head Cam, Custom Colors, Plexiglass View Window, Removeable Door (no hinge). WB, & PW Options: Also include Mortise Cam Latch, Mortise Deadbolt Lock and Mortise Slam Latch.

See Optional Colors and Locks on Page 12.



MODEL WB



MODEL PW



MODEL PWE

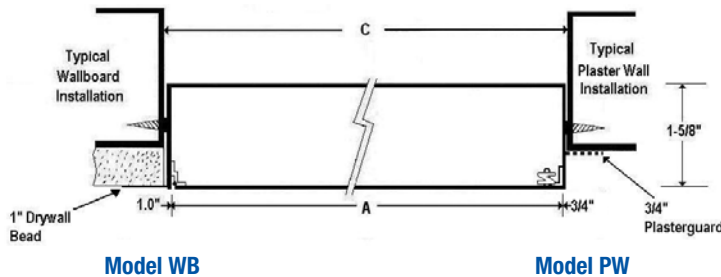

Model WB

Model PW

Door Sizes and Wall Openings				
A-Model Size	C-Wall Opening Dimension		Shipping Weight WB,PW,PWE	Latch(es)
	WB	PW & PWE		
8" x 8"	8 1/2" x 8 1/2"	-	4 lbs.	1
10" x 10"	10 1/2" x 10 1/2"	-	5 lbs.	1
12" x 12"	12 1/2" x 12 1/2"	12 1/4" x 12 1/4"	7 lbs.	1
14" x 14"	14 1/2" x 14 1/2"	-	8 lbs.	1
16" x 16"	16 1/2" x 16 1/2"	16 1/4" x 16 1/4"	10 lbs.	1
16" x 20"	-	16 1/4" x 20 1/4"	12 lbs.	1
18" x 18"	18 1/2" x 18 1/2"	18 1/4" x 18 1/4"	12 lbs.	3
22" x 22"	22 1/2" x 22 1/2"	-	16 lbs.	4
22" x 30"	22 1/2" x 30 1/2"	-	21 lbs.	4
24" x 24"	24 1/2" x 24 1/2"	24 1/4" x 24 1/4"	19 lbs.	4

Custom Sizes and Special Modifications Available Upon Request

Most Sizes Above in Stock at One of Our 7 US Warehouses for Next Day Shipping - See Stock List.

Order Format	Style Code	Width	Height	Lock (C Standard or Optional)	Optional Color Code Pg 12
For Above Models:	Style Code	Width	Height	Lock (C Standard or Optional)	Optional Color Code Pg 12
Example: WB-1212SCH-R					

INTERIOR ACCESS PANELS: CONCEALED FRAME



MODEL CTWB



MODEL CT



MODEL CP

CONCEALED FRAME FLUSH ACCESS PANELS FOR PLASTER OR TILE/WALLBOARD INSERT: CP, CT and CTWB Series

CTWB: Recessed Door for Wallboard Insert: (Wall or Ceiling):
Door face is recessed 1" to accept wallboard insert to match surrounding surface. This access door provides the most seamless look of all JL models.

Frame: 16 gauge steel.

Door: 18 gauge steel, recessed 1" for drywall covering, with continuous hinge.

Finish: White powder-coat finish.

Lock: Flush screwdriver-operated cam (C).

CT: Recessed Door for Acoustic Tile Insert: (Wall or Ceiling):

Not for use with suspended ceiling -requires installation into joists.

Door face is recessed 1" to accept application of acoustic tile or wallboard to match surrounding surface.

Frame: 16 gauge steel.

Door: 18 gauge steel, recessed 1" for tile or drywall covering with continuous hinge.

Finish: White power-coat finish.

Lock: Flush screwdriver-operated cam (C).

CP: Recessed Panel for Plaster (Wall or Ceiling)

Door face has Plasterguard in 1/2" Recess, and the frame features 3" expanded metal lath wings to accept application of plaster to match surrounding plaster walls.

Frame: 16 gauge Steel with 3/4" plasterguard and with an additional 3" wide wing of metal lath for a plaster application to the edge of the door.

Door: Metal lath over 18 gauge steel with continuous hinge.

Finish: Gray powder coat primer.

Lock: Flush screwdriver-operated cam (C).

See Optional Colors and Locks on Page 12.

Options: Cylinder Lock, Torx, Spanner or Hex Head Cam. CT and CTWB are available with recessed door depth from 1/4" to 7/8".

Door Sizes and Wall Openings					
A-Model Size	C-Wall Opening Dimension CT, CTWB & CP	Approx. Shipping Weight			Latch(es)
		CT	CTWB	CP	
12" x 12"	12 1/4" x 12 1/4"	7 lbs.	7 lbs.	9 lbs.	1
12" x 24"	12 1/4" x 24 1/4"	11 lbs.	11 lbs.	14 lbs.	2
18" x 18"	18 1/4" x 18 1/4"	12 lbs.	12 lbs.	14 lbs.	3
22" x 30"	22 1/4" x 30 1/4"	21 lbs.	21 lbs.	21 lbs.	4
24" x 24"	24 1/4" x 24 1/4"	19 lbs.	19 lbs.	20 lbs.	4
24" x 36"	24 1/4" x 36 1/4"	27 lbs.	27 lbs.	31 lbs.	5

Custom Sizes and Special Modifications Available Upon Request

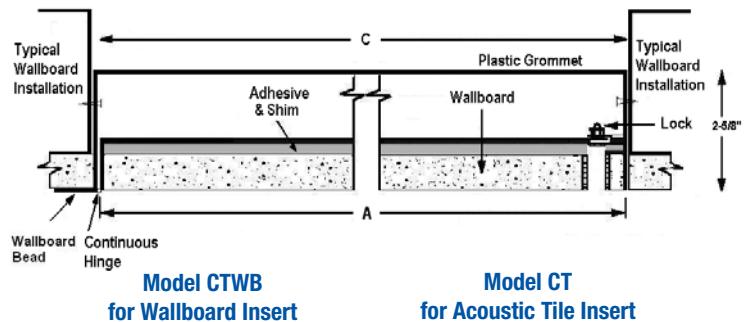

Model CTWB for Wallboard Insert

Model CT for Acoustic Tile Insert

Order Format

For Above Models:

Style Code

Width

Height

Lock (C Standard or Optional)

Optional Color Code

Example: CTWB-1212CA



WEATHER-RESISTANT FLUSH ACCESS PANEL: XP Series

XPA: Weather-resistant Flush Access Panel

Frame: 16 Gauge Galvanized Steel Frame with 1" Flange.
Door: 2" Thick Insulated .040 Aluminum Door with Continuous Stainless Steel Hinges and EPDM Foam Rubber Bulb Seal Gasketing.
Finish: Gray powder coat primer.
Lock: Non-locking (H) Die Cast Zinc Handles for Exterior, Interior has Non-locking handle.

XPS: Weather-resistant Stainless Steel Access Panel

Frame: 16 Gauge Stainless Steel Frame with 1" Flange.
Door: 2" Thick Insulated 20 Gauge Stainless Steel Door with Continuous Stainless Steel Hinges and EPDM Foam Rubber Bulb Seal Gasketing.
Finish: #304 Stainless – #4 Finish.
Lock: Non-locking (H) Die Cast Zinc Handles for Exterior, Interior has Non-locking handle.

XPA-PWE: Weather-resistant Access Panel For Plaster and Stucco Exteriors

Frame: 16 Gauge Galvanized Steel Frame with 3" Galvanized Lath Wing.
Door: 2" Thick Insulated .040 Aluminum Door with Continuous Stainless Steel Hinges and EPDM Foam Rubber Bulb Seal Gasketing.
Finish: Gray powder coat primer.
Lock: Non-locking (H) Die Cast Zinc Handles for Exterior, Interior has Non-locking handle.

XPS-PWE: Weather-resistant Stainless Steel Access Panel For Plaster and Stucco Exteriors

Frame: 16 Gauge Stainless Steel Frame with 3" Galvanized Lath Wing.
Door: 2" Thick Insulated 20 Gauge Stainless Steel Door with Continuous Stainless Steel Hinges and EPDM Foam Rubber Bulb Seal Gasketing.
Finish: #304 Stainless – #4 Stainless Steel.
Lock: Non-locking (H) Die Cast Zinc Handles for Exterior, Interior has Non-locking handle.

Options at additional Cost: Colors on Page 12. Optional Chrome-Plated Locking Handle (HL).



MODEL XPA



MODEL XPA-PWE

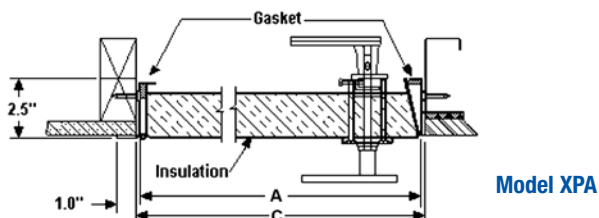

Model XPA

Door Sizes and Wall Openings: Models XPA, XPS, XPA-PWE, AND XPS-PWE							
A-Models XPA and XPS Sizes	C-Wall Opening W x H	Number of Handles	Approximate Shipping Weight	A-Models XPA and XPS Sizes	C-Wall Opening W x H	Number of Handles	Approximate Shipping Weight
12" x 12"	12 3/8" x 12 3/8"	1	11 lbs.	24" x 30"	24 3/8" x 30 3/8"	2	40 lbs.
14" x 14"	14 3/8" x 14 3/8"	1	15 lbs.	24" x 36"	24 3/8" x 36 3/8"	2	42 lbs.
18" x 18"	18 3/8" x 18 3/8"	1	19 lbs.	24" x 48"	24 3/8" x 48 3/8"	2	57 lbs.
20" x 24"	20 3/8" x 24 3/8"	1	30 lbs.	30" x 30"	30 3/8" x 30 3/8"	2	44 lbs.
20" x 30"	20 3/8" x 30 3/8"	1	32 lbs.	30" x 36"	30 3/8" x 36 3/8"	2	56 lbs.
22" x 30"	22 3/8" x 30 3/8"	1	34 lbs.	36" x 36"	36 3/8" x 36 3/8"	2	61 lbs.
22" x 36"	22 3/8" x 36 3/8"	2	40 lbs.	36" x 48"	36 3/8" x 48 3/8"	2	75 lbs.
24" x 24"	24 3/8" x 24 3/8"	2	27 lbs.	48" x 48"	48 3/8" x 48 3/8"	4	108 lbs.

Custom Sizes Available Upon Request

Order Format _____ - _____ - _____ - _____ - _____

For Above Models: **Style Code** **Width** **Height** **Lock (H or HL)** **Optional Color Code Pg 12**

Example: XPA-1212HL- B

SECURITY ACCESS PANELS



MODEL SP

Shown with Detention Deadbolt Lock Installed



MODEL HSP

Shown with Mortise Deadbolt Lock Installed

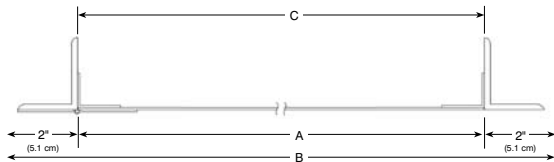

Model SP

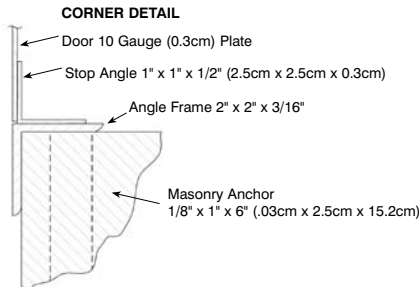

DETENTION DEADLOCK PREP (DDP)

Provided standard with the SP or HSP access panels.

The door will be prepped for a right or left-handed, heavy-duty lock to be provided and installed by others.

The prep plate is factory welded, primed & painted as an integral part of the door.

FLAT FRAME STEEL SECURITY PANEL: SP Series

Frame: 2" x 2" x 3/16" angle frame with 2" Flange, welded at corners

Door: 10 gauge plate steel door mounted on two heavy-duty detention hinges welded to the frame.

Finish: Gray powder coat primer.

Lock: Detention Deadlock Prep (DDP) provided standard with SP and HSP access panels. Lock to be provided by others. See page 9 for lock options.

Anchors: Heavy duty steel masonry anchors welded to frame at factory.

FLAT FRAME STEEL HIGH SECURITY PANEL: HSP Series

Frame: 2" x 3" x 3/16" angle frame with 2" Flange, welded at corners.

Door: 7 gauge box-formed steel door mounted on two heavy-duty 4" butt hinges welded to the frame.

Finish: Gray powder coat primer .

Lock: Detention Deadlock Prep (DDP) provided standard with SP and HSP access panels. Lock to be provided by others. See page 9 for lock options.

Anchors: Heavy duty steel masonry anchors welded to frame at factory.

Options for SP and HSP: #4 Finish Stainless Steel, Detention Slam Lock Prep (DSP), Mortise Deadbolt Prep (MDP) or Mortise Cylinder Cam Lock Prep (MP)- Locks to be Provided by Others. Detention Deadlock Installed (DD15010), Detention Slam Lock Installed (DD15017), Mortise Deadbolt Installed (MDP-SL-AMP or MDP-SL-1E74), Mortise Cylinder Cam Lock Installed (MP-SL-AMP or MP-SL-1E74).

See Optional Colors on Page 12

See Lock Selections on Page 9.

Door Sizes and Wall Openings: Model SP and HSP						
A-Door Size Width x Height	B-Outside Frame Dimensions		C-Wall Opening		Approx. Shipping Weight	Latch(es)
	Width	Height	Width	Height		
8" x 8"	12"	12"	8 3/4"	8 3/4"	16 lbs.	1
10" x 10"	14"	14"	10 3/4"	10 3/4"	20 lbs.	1
12" x 12"	16"	16"	12 3/4"	12 3/4"	24 lbs.	1
14" x 14"	18"	18"	14 3/4"	14 3/4"	29 lbs.	1
16" x 16"	20"	20"	16 3/4"	16 3/4"	32 lbs.	1
18" x 18"	22"	22"	18 3/4"	18 3/4"	38 lbs.	1
24" x 24"	28"	28"	24 3/4"	24 3/4"	52 lbs.	1
24" x 36"	28"	40"	24 3/4"	36 3/4"	72 lbs.	2
24" x 48"	28"	52"	24 3/4"	48 3/4"	90 lbs.	2

Add 1 lb. for Mortise Deadbolt Prep, or 4 lbs. for Detention Lock installed. **For Model SP Panels of 32" or Larger, We Recommend Security Screws be Installed with Lock for Additional Security. Custom Sizes and Modifications Available Upon Request

Order Format

For Above Models: **Style Code** **Width** **Height** **Lock (DDP Standard or Optional)** **Color Code (page 12)**

Example: **HSP-1212MDP-SL-AMP-FBK**

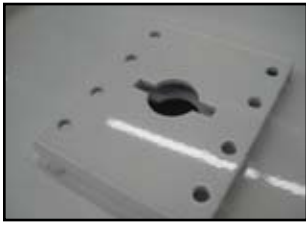

DETENTION SLAM LOCK PREP (DSP)

This option is available at no additional cost and includes a door which is prepped for a detention slam latch to be provided and installed by others. The prep plate is factory welded, primed & painted as an integral part of the door. Lock and mounting bolts are not included. Please specify the manufacturer and model number of the lock to ensure compatibility. (Not available on Security Fire Extinguisher Cabinets)



Mortise Deadbolt Prep (MDP)

This option is available at additional cost and includes a lock mechanism which is prepped for a mortise cylinder and cam to be provided and installed by others. The prep includes a 2-1/2" x 3-1/2" x 1-3/4" case with installed Lori assembly with 1" x 5/8" throw. Lock and mounting bolts are not included. The mortise cylinder must be 1-1/8" (3.2cm) in diameter and the recommended cylinder length is 1-1/2" (3.8 cm). (A longer cylinder can be adapted to it by using a rose spacer. The cam must be an Adam Rite cam.)

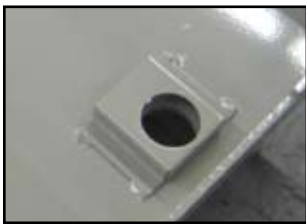

Mortise Cylinder Cam Lock Prep (MP)

This option is available at no additional cost and includes a door which is prepped for a mortise cylinder and cam to be provided for and installed by others. Lock and mounting bolts are not included. The mortise cylinder must be 1-1/8" (3.2cm) in diameter and the recommended cylinder length is 1-1/2" (3.8 cm). (A longer cylinder can be adapted to it by using a rose spacer) The cam must be 3/4" (1.91 cm) long, as measured from the edge of the cylinder to the tip of the cam.

Detention Deadlock Installed (DDI5010)

Right-handed, heavy-duty detention lock installed at the factory. The prep plate is factory welded, primed & painted as an integral part of the door. Model 5010 is a medium security deadbolt with a single piece, paracentric key cylinder in a high tensile strength, alloy steel case, keyed 1 side. The deadbolt is fabricated of 1-1/2" x 3/4" hot rolled steel with a 5/8" throw. All steel parts are plated for corrosion resistance. Dimensions 1-1/4" x 4-1/2" x 3". Keys to be ordered separately, please specify the number of keys to be ordered with this lock. Security Torx bolts secure the lock to the door.



Detention Slam Lock Installed (DDI5017)

Right-handed, heavy-duty detention lock installed at the factory. The prep plate is factory welded, primed & painted as an integral part of the door. Model 5017 is a medium security slam latch with a stainless steel latchbolt with 1" x 7/16" throw. Slam-locks automatically when door is closed. Lock is constructed with a single piece, bronze alloy paracentric key cylinder, 5 tempered brass lever tumblers keyed one side (K1) in a high-tensile strength alloy steel case. All steel parts plated for corrosion resistance. Dimensions: 1 1/4" x 4" x 2 3/4". Keys to be ordered separately, please specify the number of keys to be ordered with this lock. Security Torx bolts secure the lock to the door.



Mortise Deadbolt Installed (MDP-SL-AMP or MDP-SL-1E74)

Mortise deadbolt installed at the factory includes a 2-1/2" x 3-1/2" x 1-3/4" case welded to the door with installed Lori assembly with 1" x 5/8" throw. Select from lock models (AMP) in satin chrome with Yale Standard cam and keys (drilled 6 pin, keyed 5 pin), or 1E74 with a blank construction core to be keyed on site. Both locks are machined from solid brass bar stock. The mortise cylinder is 1-1/8" (3.2cm) in diameter and the cylinder length is 1-1/2" (3.8 cm). Security Torx bolts secure the lock to the door.



Mortise Cylinder Cam Lock Installed (MP-SL-AMP or MP-SL-1E74)

Cylinder lock with heavy-duty 7/16" cam installed at the factory. The prep plate is factory welded, primed & painted as an integral part of the door. Select from lock models (AMP) with 2 Yale Standard keys, or 1E74 with a blank construction core to be keyed on site. Both locks are machined from solid brass bar stock. The mortise cylinder is 1-1/8" (3.2cm) in diameter and the cylinder length is 1-1/2" (3.8 cm).



INTERIOR ACCESS PANELS: SPECIALTY



MODEL ATM PANEL

**VERSATILE
MANUFACTURING
CAPABILITIES**

We're Ready to Help—Just Ask Us!

GASKETED ACCESS PANEL: ATM Series

This Gasketed Panel is ideal for laboratories, pressurized rooms, climate-controlled rooms, dusty or high-moisture environments. The frame and door are specially designed to form a tight seal reducing air infiltration.

Frame & Trim: 16 gauge CRS with 3/8" retainer channel for gasket, and 1" trim flange.

Door: 16 gauge rolled and welded. Cam-operated closure with knurled knob compresses door tightly to gasket.

Gasket: Fully gasketed on all sides with EPDM rubber.

Finish: Gray powder coat primer.

Options: Flush Handle (shown on website), stainless, galvanized.

Optional Colors on Page 12

A-Model Size Width x Height	B-Outside Frame Dimensions		C-Wall Opening Dimensions		Approx. Shipping Weight	Latch(es)
	Width	Height	Width	Height		
12" x 12"	14"	14"	12 3/8"	12 3/8"	7 lbs.	1
18" x 18"	20"	20"	18 3/8"	18 3/8"	16 lbs.	1
24" x 24"	26"	26"	24 3/8"	24 3/8"	28 lbs.	2
24" x 36"	26"	38"	24 3/8"	36 3/8"	42 lbs.	2

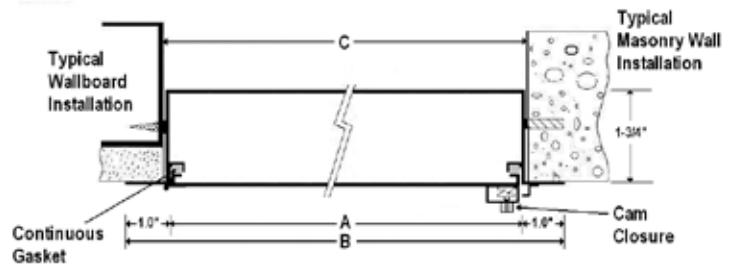

Model ATM



MODEL SMT PANEL

SURFACE-MOUNT ACCESS PANEL: SMT Series

The SMT is an economical surface-mounting panel that quickly and easily installs with screws through the corners of the frame. It is suitable for installation in wallboard or plaster.

Trim & Door: 1" wide, 16 gauge trim with screw holes in each corner for mounting. 16 gauge door operates on a continuous hinge.

Finish: Gray powder coat primer.

Lock: Screwdriver-operated cam lock (C).

Options: #4 Satin Finish Stainless Steel, Custom Colors, Knob Cam, Torx, Spanner or Hex Head Cam.

See Optional Colors and locks on Page 12.

A-Model Size Width x Height	B-Outside Frame Dimensions		C-Wall Opening Dimensions		Approx. Shipping Weight	Latch(es)
	Width	Height	Width	Height		
8" x 8"	10"	10"	8"	8"	3 lbs.	1
12" x 12"	14"	14"	12"	12"	7 lbs.	1
16" x 16"	18"	18"	16"	16"	12 lbs.	1
24" x 24"	26"	26"	24"	24"	27 lbs.	4

Order Format

For Above Models: **Style Code** **Width** **Height** **Lock for SMT Only (C Standard or Optional)** **Color Code (page 12)**

Example: **ATM-1818**



ALUMINUM ANGLE FLOOR DOOR: AAF Series

Construction: Frames are extruded aluminum shapes specially designed for floor doors. This door is made from reinforced 1/4 diamond plate for greater strength.

Hardware: Stainless steel hinges are bolted to the door and frame to minimize galvanic corrosion. All fasteners are tamperproof stainless steel bolts. Stainless steel slam locks, gas assist opener, hold open arm.

Finish: Mill with bituminous coating below grade.

Load: 300 lbs./ft.²



Model	Clear Opening	Single (S) Door	Approx. Weight
AAF-2424S	23" x 23"	S	60 lbs.
AAF-2436S	23" x 35"	S	76 lbs.
AAF-3030S	29" x 29"	S	81 lbs.
AAF-3036S	29" x 35"	S	92 lbs.
AAF-3636S	35" x 35"	S	100 lbs.
AAF-3048S	29" x 47"	S	115 lbs.
AAF-3648S	35" x 47"	S	118 lbs.
AAF-4242S	41" x 41"	S	120 lbs.

Custom Sizes Available Upon Request

Model	Clear Opening	Double (D) Door	Approx. Weight
AAF-4848D	47" x 47"	D	154 lbs.
AAF-4860D	47" x 59"	D	173 lbs.
AAF-4872D	47" x 71"	D	208 lbs.
AAF-6060D	59" x 59"	D	215 lbs.

Custom Sizes Available Upon Request

ALUMINUM GUTTER FLOOR DOOR: AGF Series

Construction: The door frames are an engineered gutter frame design in extruded aluminum shapes specially designed for floor doors. The gutter is equipped with 1 1/2" FTP drain coupling allowing for water runoff. The door is made from reinforced 1/4" diamond plate for greater strength. The door is hinged such that when open, the door does not penetrate the gutter, thus preventing problems due to freezing or contaminating build-up.

Hardware: Stainless steel hinges are bolted to the door and frame to minimize galvanic corrosion. All fasteners are tamperproof stainless steel bolts. Stainless steel slam locks, gas assist opener, hold open arm.

Finish: Mill with bituminous coating below grade.

Load: 300 lbs./ft.²

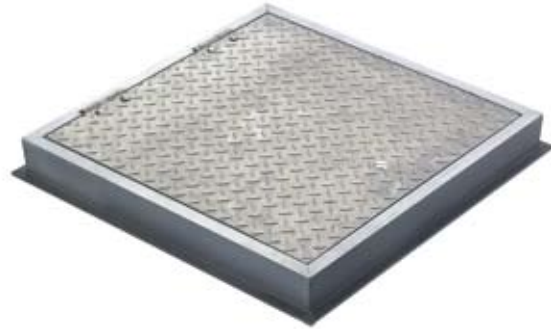

Model	Clear Opening	Single (S) Door	Approx. Weight
AGF-2424S	20 1/2" x 20 1/2"	S	60 lbs.
AGF-2436S	20 1/2" x 32 1/2"	S	76 lbs.
AGF-3030S	26 1/2" x 26 1/2"	S	81 lbs.
AGF-3036S	26 1/2" x 32 1/2"	S	92 lbs.
AGF-3636S	32 1/2" x 32 1/2"	S	100 lbs.
AGF-3048S	26 1/2" x 44 1/2"	S	115 lbs.
AGF-3648S	32 1/2" x 44 1/2"	S	118 lbs.
AGF-4242S	38 1/2" x 38 1/2"	S	120 lbs.

Custom Sizes Available Upon Request

Model	Clear Opening	Double (D) Door	Approx. Weight
AGF-4848D	44 1/2" x 44 1/2"	D	154 lbs.
AGF-4860D	44 1/2" x 56 1/2"	D	173 lbs.
AGF-4872D	44 1/2" x 68 1/2"	D	208 lbs.
AGF-6060D	56 1/2" x 56 1/2"	D	215 lbs.

Custom Sizes Available Upon Request

OPTIONS

LOCK OPTIONS FOR: TM, TMS, WB, PWE, SMT AND PW Series



CYLINDER LOCK (L)



MORTISE CAM LATCH PREP (MP)
INSTALLED (MPI)



MORTISE DEABOLT PREP (LL)
INSTALLED (LLI)



MORTISE SLAM LATCH PREP (UM)
INSTALLED (UMI)



KNOB CAM (KK)



TORX HEAD CAM (CT)



HEX HEAD CAM (CA)



SPANNER HEAD CAM (SHC)



RAINHOOD (RH)



GASKETING (CG)

COLOR OPTIONS:

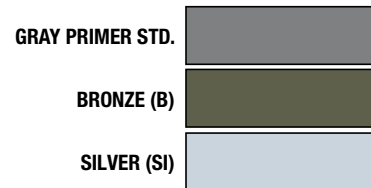
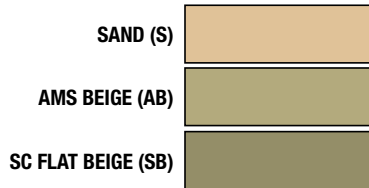

Note: Colors are approximate. For color/finish samples contact customer service.

WARRANTY: All access panel products carry a one year warranty after date of shipment against defects in materials and workmanship. We will replace or repair any product found defective within this period at our discretion. No other warranty express or implied is valid.

MANUFACTURING/WAREHOUSING LOCATIONS

VISA  **MasterCard**

ACPG WEST COAST WAREHOUSE
RENTON, WASHINGTON

ACPG WEST COAST SAMSON PRODUCTS
6285 RANDOLPH STREET, COMMERCE, CA 90040
PHONE: 800-554-6077 FAX: 952-835-2218
E-MAIL: SALES@SAMSONPRODUCTS.COM
WEB SITE: WWW.SAMSONPRODUCTS.COM

ACPG HEADQUARTERS
JL INDUSTRIES
4450 W. 78TH STREET CROIE, BLOOMINGTON, MN 55435 Phone
800-554-6077 Fax: 952-835-2218
E-MAIL: SALES@JLINDUSTRIES.COM
Web Site: WWW.JLINDUSTRIES.COM

ACPG SOUTH WAREHOUSE
GRAND PRAIRIE, TEXAS

ACPG CHICAGO WAREHOUSE
WOOD DALE, ILLINOIS

ACPG ATLANTA WAREHOUSE
ATLANTA, GEORGIA

ACPG EAST COAST WAREHOUSE
LANCASTER, PENNSYLVANIA

ACPG SOUTHEAST
THOMAS ENTERPRISES
5765 CORPORATION CIRCLE, FORT MYERS, FL 33905
PHONE: 800-780-7501 FAX: 239-693-7501
E-MAIL: SALES@THOMASE.COM
WEB SITE: WWW.THOMASE.COM

The Activar Construction Products Group (ACPG) consists of 5 affiliated companies that serve the commercial construction industry. Our multiple product lines are a single source for architects and distributors. Air Louvers manufactures products for the openings market with door lites, louvers and rated-glass. Hiawatha is known for its quality architectural door hardware and frameless shower door products. JL Industries is an industry leader in fire protection, providing fire extinguishers, AEDs and cabinets, access panels, roof opening products and entrance flooring systems. Samson Products manufactures many of the products sold under the JL label and distributes JL products on the West Coast. Thomas Enterprises is our Southeast distributor for JL products and has a state-of-the-art aluminum fabrication facility for fire extinguisher cabinets sold under the Thomas and JL labels.



JL INDUSTRIES

CORNER GUARD SYSTEMS

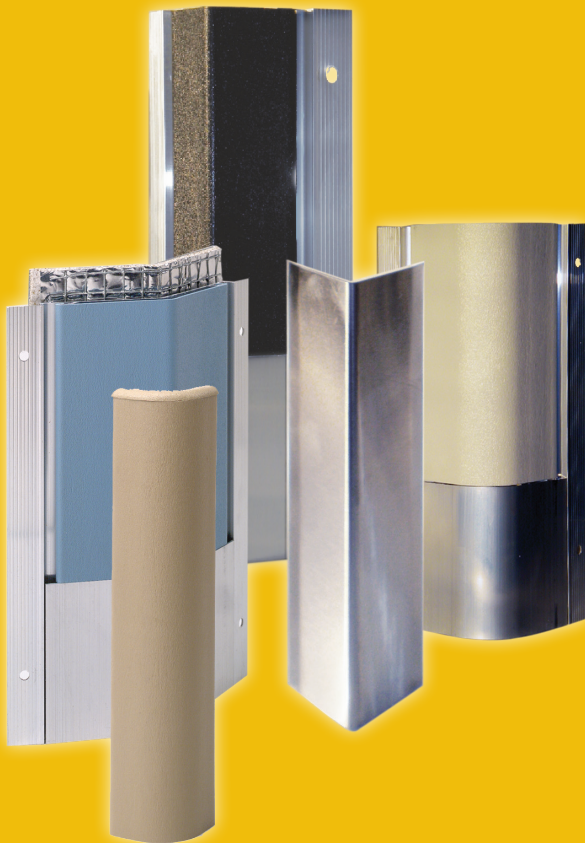

**Division 10 26 13
Corner Guards**

ACTIVAR
INC.

www.activar.com

Construction Products Group



SAF-T-GUARD SYSTEMS

VINYL CORNER GUARD SYSTEM: SGV Series

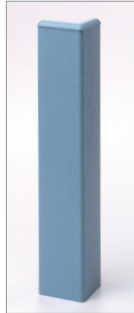

SGVS-90-2



SGVR-90-2

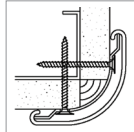

Construction: Continuous aluminum retainer with high-impact vinyl acrylic cover completely conceals frame. Installations less than 8' high provided with end cap.

Length: 48" standard". Up to 20'.

Wing Length: 2" and 3".

Angle: 90° (2" & 3" wing), 135° (3" wing).

Corner Type: Square (S), Radius (R) or Endwall (EW).

Mounting: Installed with screws through aluminum retainer to wallboard surface.

Flame Resistance: Meet Class 1/A requirements for flame spread and smoke density.

FLUSH VINYL CORNER GUARD SYSTEM WITH ALUMINUM BASE & WALLBOARD BEAD: SGVA Series



SGVAS-90-3



SGVAR-90-3

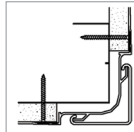

Construction: Continuous aluminum retainer with 4" cover base. High-impact vinyl acrylic cover snaps into place concealing frame except for 3/16" trim.

Length: 48" standard". Up to 20'.

Wing Length: 2" and 3" with 13/16" tapered wallboard bead for taping over frame.

Angle: 90° (2" & 3" wing), 135° (3" wing).

Corner Type: Square (S), Radius (R), or Endwall (EW).

Mounting: Installed with screws through aluminum retainer to wallboard surface.

Flame Resistance: Meet Class 1/A Requirements for Flame Spread and Smoke Density.

FLUSH VINYL CORNER GUARD SYSTEM 1 OR 2 HR FIRE-RATED WITH ALUMINUM BASE & WALLBOARD BEAD: SGVAF Series



SGVAF1R-90-3



SGVAF2S-90-3

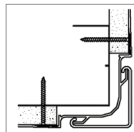

Construction: Continuous aluminum retainer with 4" cover base. High-impact vinyl acrylic cover snaps into place concealing frame except for 3/16" trim.

Fire-Rated Insulation: 1 or 2 hour fire-rated material is adhered to the wall side of the corner guard.

Length: 48" standard". Up to 20'. 

Wing Length: 2" and 3" with 13/16" tapered wallboard bead for taping over frame.

Angle: 90° (2" & 3" wing), 135° (3" wing).

Corner Type: Square (S) or Radius (R) or Endwall (EW).

Mounting: Installed with screws through aluminum retainer to wallboard surface.

Flame Resistance: Meet Class 1/A Requirements for Flame Spread and Smoke Density.

Ordering: Use SGVAF1 for 1 Hour and SGVAF2 for 2 Hour.

Endwalls Includes Matched Sheet Wall Protection



SCVA-EW



SCVEW

Color Selection for All Models on This Page: See Page 2



CORNER GUARDS: STAINLESS STEEL, VINYL & LEXAN

STAINLESS STEEL: CGSS Series MEDIUM TO HEAVY IMPACT



Finish & Material: 18 Gauge, Type 304, 32D #4 Satin Finish (BHMA 630).
Length: 48" standard". Up to 96".
Wing Length: Standards are 1-1/2", 2", 2-1/2", 3" and 3-1/2". Others available upon request.
Angle: Standards are 90°, 135° or "U" Shape.
Mounting: Screws and pre-drilled holes, or adhesive strips upon request.
Flame Resistance: Non-flammable.

CLEAR LEXAN® POLYCARBONATE: CGL Series LIGHT TO MEDIUM IMPACT



Length: 48" or 8' standard". Others available upon request.
Wing Length: Standards are 3/4", 1-1/8", 1-1/2", 2" and 2-1/2". Others available upon request.
Angle: Standards are 90°, 135° (135° only available in 2-1/2" wing).
Mounting: Screws and pre-drilled holes.
Flame Resistance: None.

TEXTURED STAINLESS STEEL: CGSST Series LIGHT TO MEDIUM IMPACT

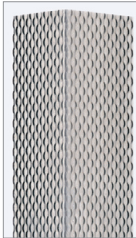

CGSST-90-B

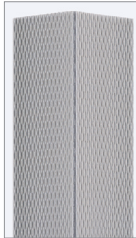

CGSST-90-R

Finish & Material: Type 304 stainless, gauge varies by texture selected.
Length: 48" standard". Other lengths available upon request.
Wing Length: Standards are 1-1/2", 2", 3" and 3-1/2". Others available upon request.
Angle: Standards are 90°, 135° or "U" Shape. Others available upon request.
Mounting: Adhesive, or screws and pre-drilled holes.
Flame Resistance: Non-flammable.
Textures: (BW) Basketweave, (B) Bounce, (C) Cobblestone, (HA) Hammered, (HC) Honeycomb, (L) Leather, (PB) Pebble, (PS) Pinstripe, (S) Stucco, (W) Wave, (R) Rice, (BR) Brick.
 See Website to View Samples.

VINYL ACRYLIC: CGVA Series LIGHT TO MEDIUM IMPACT

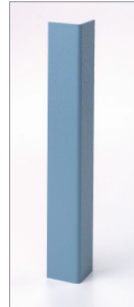

CGVA-90-1.5

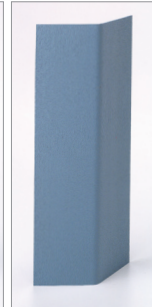

CGVA-135-2.75

Finish & Material: Lightly textured, formed .078" Vinyl Acrylic.
Length: 48" standard". Up to 18'.
Wing Length: Any width 1-2 3/4" Others available upon request.
Angle: Standards are 90° and 135°. Others available upon request.
Mounting: Adhesive, or Screws and pre-drilled holes.
Flame Resistance: Meet Class 1/A Requirements for Flame Spread and Smoke Density.
Ratings: ASTM D4226 and ASTM D256.

Colors for all Vinyl Corner Guards:

Group 1 (Quickship) - (09) Moonlight, (56) Linen, (01) Parchment, (59) Canvas, (18) Desert Beige, (06) Morning Mist, (05) Mojave, (02) Pueblo.

Group 2 (Standard) - (26) Birchbark, (23) Glacier Blue, (53) Ivory, (37) Misty Peach, (27) Cornflower, (17) Jasmine, (04) Dolphin, (13) Silk, (41) Sky Blue, (11) Winter Sky, (40) Taupe, (54) Cloud, (39) Teal, (19) Black. Others available upon request. See Website to view Color Samples.

Order Format: _____ - _____ - _____ - _____ - _____ Example: CGSST-90-3.5-60-PB
 Model Degree of Angle Wing Length Total Length Texture or Color SGVAF2S-135-3-90-23

TO ORDER CALL 1-800-554-6077 OR VISIT WWW.JLINDUSTRIES.COM

HEADQUARTERS: 4450 WEST 78TH ST CIRCLE, BLOOMINGTON, MN 55435-5416 **PH:** 800-554-6077 **FAX:** 952-835-2218
EMAIL: SALES@JLINDUSTRIES.COM **WWW.ACTIVARCPG.COM** **ACPG WEST COAST (SAMSON PRODUCTS):** COMMERCE, CA
ACPG SOUTHEAST (THOMAS ENTERPRISES): FT MEYERS, FL **PH:** 239-693-7500
WAREHOUSES: DALLAS TX, LANCASTER PA, CHICAGO IL, ATLANTA GA
AN ACTIVAR CONSTRUCTION GROUP COMPANY

The Activar Construction Products Group (ACPG) consists of 5 affiliated companies that serve the commercial construction industry. Our multiple product lines are a single source for architects and distributors. Air Louvers manufactures products for the openings market with door lites, louvers and rated-glass. Hiawatha is known for its quality architectural door hardware and frameless shower door products. JL Industries is an industry leader in fire protection, providing fire extinguishers, AEDs and cabinets, access panels, roof opening products and entrance flooring systems. Samson Products manufactures many of the products sold under the JL label and distributes JL products on the West Coast. Thomas Enterprises is our Southeast warehouse distributor for JL products and has a state-of-the-art aluminum fabrication facility for fire extinguisher cabinets sold under the Thomas and JL labels.

SUBMITTALS AVAILABLE AT: WWW.JLINDUSTRIES.COM

CG1002



JL INDUSTRIES

FIRE PROTECTION



Division 10 44 00

**Fire Extinguisher Cabinets
Security Fire Extinguisher
Cabinets**

**Fire Extinguishers
Fire Blankets and Cabinets
Fire Extinguisher Accessories**

Division 21 12 00

**Hose Racks
Valve and Hose Cabinets
Hoses & Nozzles**



ACTIVAR
INC.

Construction Products Group



JL INDUSTRIES



AIR LOUVERS



SAMSON PRODUCTS



THOMAS ENTERPRISES



HIAWATHA

INTRODUCTION

ABOUT JL INDUSTRIES

Choices and Quality: We offer you the convenience of the full range of products from JL Industries, Samson Products and Thomas Enterprises complete in one catalog.

Here you can find the largest selection of fire extinguisher cabinets in the industry, including steel, stainless steel, aluminum, brass and bronze with a host of optional features. JL's reputation for quality products has made us an industry standard for over 65 years.

Fast Delivery: Take advantage of our Quick-Ship Program for the most popular cabinet models. We ship direct to you from eight locations in North America. See the back page for locations.

LEED Credits: Most of our products can contribute to your LEED project. Contact us or visit our website for more information.

Versatile Manufacturing Capabilities: With the combined resources of our three manufacturing facilities—each with its own specialty—you can create your own distinctive cabinet with the size and features you need, for the look you want. Just Ask Us!

Our involvement with organizations such as the National Fire Prevention Association (NFPA), the Door and Hardware Institute (DHI), the Construction Specifiers Institute (CSI), the Green Building Council and the National Association of Fire Equipment Distributors (NAFED) enables us to remain at the forefront of industry requirements with products to keep you in compliance with current building codes.

Made in U.S.A.: Most products meet the American Recovery and Reinvestment act of 2009 (ARRA), Section 1605 "Buy American". Contact us or visit our website for more information.

Website Resources: Find all of the documentation you need and the most current product information on our website at WWW.JLINDUSTRIES.COM.

WARRANTY

All fire protection products carry a one-year warranty after date of shipment against defects in materials and workmanship. We will replace or repair any product found defective within this period at our discretion. No other warranty express or implied is valid. Fire extinguishers may carry a longer warranty.

AMERICANS WITH DISABILITIES ACT (ADA) GUIDELINES

Look for Model Numbers in Blue to find cabinets that comply with ADAC.

- Cabinets with the number "2" as the fourth character of the model number. These models project only 4" from the wall and include a flush pull.
- All trimless and flat trim models with any handle.
- All 1 1/4", 1 1/2", 2 1/2" or 3" trim models with any handle—excluding bubble cabinets.



Projection Requirements

The federal regulations for ADA Standards for Accessible Design Section: Protruding Objects Section (28 CFR 36, 4.4.1) specify that "objects projecting from walls with their leading edges between 27" and 80" (685 mm and 2030 mm) above the finished floor (AFF) shall protrude no more than 4" (100mm) into walks, halls, corridors, passageways, or aisles. Please note that a surface-mounted cabinet installed in such a way that any part of it falls between 27" and 80" AAF would not meet ADA requirements.

These are national standards which are subject to change by local authorities having jurisdiction. ADA requirements, in particular, are constantly evolving through ongoing legislative and judicial actions. For more information: <http://www.ada.gov>

Mounting Heights

The NFPA and ADA have created guidelines for the mounting of cabinets and extinguishers to provide safety and/or easy access to the equipment. ADA guidelines specify reach ranges for building occupants who require access to equipment such as fire extinguishers and other fire safety devices. According to the ADA Standards (28 CFR 36, 4.2.5 and 4.2.6 neither the extinguisher handle nor the cabinet handle can be mounted higher than 48" AFF for applications which allow for only a forward approach in a wheelchair to the object; and, no higher than 54" AFF, for those applications which allow for a parallel approach. It should be noted that these restrictions also fall within the current National Fire Protection Association (NFPA) guidelines, which call for a maximum mounting height of 60" AFF to the top of the extinguisher.

ADA COMPLIANT CABINET STYLES - TOP VIEW

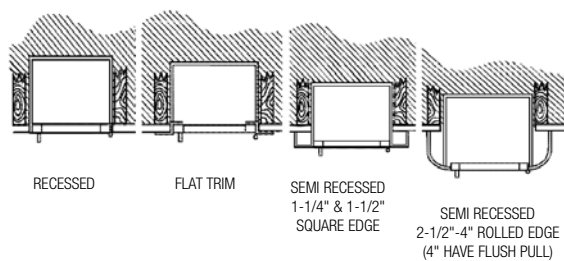

ADA MOUNTING HEIGHTS

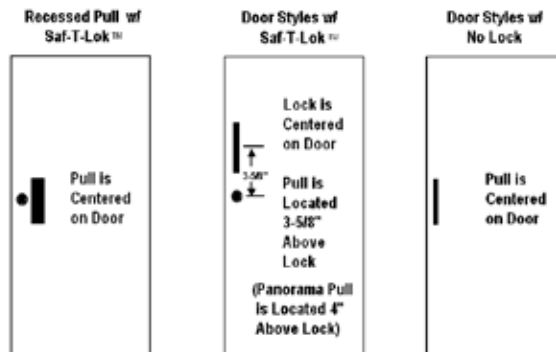



SAF-T-LOK™ OPTION

Unique design for cabinets with cylinder locks

Theft-deterrent feature with cylinder lock

In the panic of a fire emergency, the breaking of the glass in a fire extinguisher cabinet door can be dangerous. It creates the possibility of injury to people and serious liability to the building owner.

Cabinets with a **SAF-T-LOK™** lock appear to be locked and in fact are, but the door can be opened with a sharp pull which breaks the replaceable plastic cam. This deters theft and vandalism which occur from unlocked cabinets and allows quick access to the extinguisher.

The **SAF-T-LOK™** cam lock is centered top to bottom and can be installed on most door styles with the glazing option you select. Recessed pulls are centered top to bottom, and protruding pulls are installed 3-5/8" inches higher when a **SAF-T-LOK™** is installed in your cabinet.



1038Q43



FIRE-FX™ OPTION

Fire Rated Cabinets

AN INDUSTRY FIRST!

Warnock Hersey has certified and listed JL's **FIRE-FX™** Option for 1-hour and 2-hour combustible and non-combustible wall systems. All JL Industries fire equipment cabinets with **FIRE-FX™** Option are shown in red throughout our catalog.

FIRE-FX™ OPTION



- Eliminates the Need to Line the Wall Opening with Fire-Rated Material.
- Retains the Integrity of the Fire Barrier.
- Conforms to ASTM-E814-83 and UBC-43-6
- WHI Test # 631-021201 & 631-021202

Most Recessed Cabinets in our Product Line are Available as Fire-Rated Cabinets. See Product Page in This Catalog for More Information.

To order or specify, add **FIRE-FX™** Option to the end of the seven-digit JL model number. For example, if you want an Ambassador 1017F10 with the **FIRE-FX™** Option, ask for the 1017F10FX.

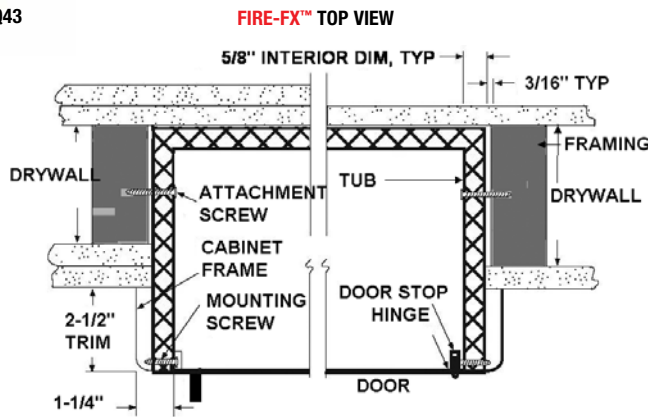

TYPICAL FIRE-RATED INSTALLATION

TABLE OF CONTENTS

STEEL

Ambassador	6-7
Classic	12
Clear Vu	9
Corner Vu	13
Crownline Valve/Hose	18-19
Decorline	13
Defibrillator	16
Economyline	12
Embassy	10
Panorama	8
Royal Blanket	20
School	16
Security	16
SMB	9

STAINLESS STEEL

Clear Vu	9
Corner Vu	13
Cosmopolitan	6-7
Crownline Valve/Hose	18-19
Defibrillator	16
Embassy	10
Panorama	8
Royal Blanket	20
School	16
Security	16

ALUMINUM

Academy	6-7
Canopy	15
Classic	12
Clear Vu	9
Corner Vu	13
Crownline Valve/Hose	18-19
Decorline	13
Defibrillator	16
Economyline	12
Embassy	10
Panorama	8
RBC	15
RC	14
Royal Blanket	20
SM	14

ABS PLASTIC & FIBERGLASS

ABS	12
FB	14

BRONZE

Cavalier	11
Clear Vu	9
Embassy	10

BRASS

Cavalier	11
Clear Vu	9
Embassy	10

EXTINGUISHERS.....4-5

AED CABINETS.....16

FIRE HOSE EQUIPMENT.....17

ACCESSORIES.....20, 21

PROJECT GALLERY.....22

KEY TO CABINET NUMBERS.....23

OPTIONAL METAL FINISHES.....24

LOCATIONS.....24

FIRE EXTINGUISHERS

COSMIC EXTINGUISHERS: Multi-Purpose Chemical

General Data: These units contain specially fluidized and siliconized mono ammonium phosphate powder, which smothers and breaks the chain reaction on Class B fires, fuses and insulates Class A fires and is a non-conductor of electricity. Non-toxic.

Operation: Squeeze the lever, which opens the valve, allowing the chemical to be forced out. Upright squeeze grip operation approved to -65°F (-52°C).

Construction: Heavy-duty steel cylinder with rugged metal valve and siphon tube with replaceable molded valve stem seal, visual pressure gauge, pull pin and upright squeeze grip. Corrosion and impact-resistant powder coat finish.

CLASS A,B,C Fires



GALAXY EXTINGUISHERS: Regular Dry Chemical

General Data: These models contain a siliconized sodium bicarbonate base, the traditional dry chemical. Cleanup after use is generally easy, because the chemical does not normally bake to a hot metal surface. Non-toxic.

Operation: Squeeze the lever, which opens the valve, allowing the chemical to be forced out. Upright squeeze grip operation approved to -65°F (-52°C).

Construction: Heavy-duty steel cylinder with rugged metal valve and siphon tube with replaceable valve stem seal, visual pressure gauge pull pin and upright squeeze grip.

CLASS B,C Fires



SATURN EXTINGUISHERS: Class K Wet Chemical

General Data: These units are ideal for commercial restaurant applications as a portable supplement to pre-engineered suppression systems. A low "pH" potassium acetate solution is discharged in a fine mist that provides excellent range while preventing splashing and creating an effective saponification foam-type blanket necessary for suppressing liquid cooking media fires.

Operation: Squeeze the lever, which opens the valve, allowing the chemical to be forced out.

Construction: Stainless steel cylinder with protective nozzle tip orifice seal and non-metallic nozzle tip finger guard. Industry standard horn and nozzle design. Name plate shows only the class "K" symbol.

CLASS K Fires



MERCURY EXTINGUISHERS: Halotron®

General Data: This model contains the clean extinguishing agent Halotron® 1, which is EPA-approved, government-accepted and specified. This agent discharges as a liquid, then quickly evaporates, leaving no residue to clean up afterwards. U.S. FAA-approved for use in airports. NIFPA-10 rating. Electrically non-conductive.

Operation: Squeeze the lever, which opens the valve, allowing the chemical to be forced out. Temperature range from -40°F to +120°F.

Construction: Drawn steel cylinder with steel siphon tubes, power cone discharge stream, upright squeeze grip visual pressure gauge and corrosion-resistant paint finish.

CLASS A,B,C Fires



SENTINEL EXTINGUISHERS: Carbon Dioxide

General Data: This extinguisher contains liquid carbon dioxide under pressure.

Operation: Squeeze the lever, which opens the valve, allowing the carbon dioxide to be forced out. The discharge, which changes into a gas and appears as a smothering cloud of white snow, is then directed to the fire through a funnel-shaped horn. Electrically non-conductive.

Construction: Lightweight, high-pressure, aluminum cylinder with O-ring seal and straight thread brass valve fits all sizes. The Sentinel is absolutely rust-free and up to 30% lighter than CO2 units with steel cylinders.

CLASS B,C Fires



272: Water Mist for Electrical

General Data: This non-toxic water mist extinguisher is ideal for Class A fires and where a potential Class C (electrical) hazard exists. Units shipped empty.

Operation: The unique misting nozzle provides safety from electrical shock, making this extinguisher ideal for use in telecommunications and cleanroom environments.

Construction: Non-magnetic cylinder and misting nozzle. For use in medical facilities.

Class A,C Fires



GRENADIER EXTINGUISHERS: Pressurized Water

General Data: The "water press" extinguisher contains water and compressed air. Units shipped empty.

Operation: Squeeze the lever, which opens the valve, allowing the water to be forced out. Upright squeeze grip operation.

Construction: Butt-welded 304-L stainless steel cylinder (eliminates all internal and external crevices). Rugged stainless steel discharge lever and fixed carry handle with visual pressure gauge, pull pin. Heavy-duty, brass, chrome-plated valve body with replaceable molded valve stem seal. UL labeled chemical engine hose.

CLASS A Fires



CLASS A FIRES - PAPER, WOOD, CLOTH, ETC., WHERE QUENCHING BY WATER OR INSULATING BY DRY CHEMICAL IS EFFECTIVE.



CLASS B FIRES - FLAMMABLE LIQUIDS WHERE SMOTHERING ACTION IS REQUIRED.



CLASS C FIRES - LIVE ELECTRICAL EQUIPMENT WHERE THE NON-CONDUCTIVITY OF EXTINGUISHANT IS VITAL.



CLASS K FIRES CALL J.L INDUSTRIES FOR MORE INFORMATION.



495: Wheeled Multi-Purpose Chemical 50-lb Unit

General Data: Portable, large-capacity extinguisher units contain specially-fluidized and siliconized mono ammonium phosphate powder which smothers and breaks the chain reaction on Class B fires, fuses and insulates Class A fires and is a non-conductor of electricity. Non-toxic.

Operation: Squeeze the lever, which opens the valve, allowing the chemical to be forced out. Upright squeeze grip operation approved to -65°F (-52°C).

Construction: Heavy-duty steel cylinder with rugged metal valve and siphon tube with replaceable molded valve stem seal, visual pressure gauge, pull pin and upright squeeze grip. Corrosion and impact-resistant powder coat finish.

CLASS A,B,C Fires

496: Wheeled Dry Chemical 50-lb Unit

General Data: These models contain a siliconized sodium bicarbonate base, the traditional dry chemical. Cleanup after use is generally easy, because the chemical does not normally bake to a hot metal surface. Non-toxic.

Operation: Squeeze the lever, which opens the valve, allowing the chemical to be forced out. Upright squeeze grip operation approved to -65°F (-52°C).

Construction: Heavy-duty steel cylinder with rugged metal valve and siphon tube with replaceable valve stem seal, visual pressure gauge, pull pin and upright squeeze grip.

CLASS B,C Fires



MODELS 495 and 496 WHEELED EXTINGUISHER

WHEELED EXTINGUISHER FEATURES: The carriage design protects the agent cylinder while providing a platform to transport and operate the units. 25' Foot hose included. Options include stationary design and tow loop.

Other types of wheeled fire extinguishers are available including carbon dioxide unit and nitrogen cylinder-operated units. Please contact JL Industries for further details.

Model	Nominal Capacity	Shipping Weight	Cylinder Diameter	Overall Height	Overall Width	Shipping Volume	U/L Rating	Optional Mark Bracket	US Coast Guard Approved
Grenadier-P	2-1/2 gal.	7.75 lbs.	7"	24-1/2"	9"	1.1 cu.ft.	2A	MB810	YES
Cosmic 2-1/2E*	2-1/2 lbs.	5.5 lbs.	3-3/8"	15-1/2"	5-3/4"	.2 cu.ft.	1A-10BC	MB817C or MB817A*	YES
Cosmic 5E	5 lbs.	10 lbs.	4-1/4"	16-3/8"	7-1/4"	.35 cu.ft.	3A-40BC	MB818C	YES
Cosmic 6E	6 lbs.	12.75 lbs.	5"	16"	7-3/4"	.5 cu.ft.	3A-40BC	MB808A	YES
Cosmic 10E	10 lbs.	18.25 lbs.	5-1/8"	21"	7-3/4"	.65 cu.ft.	4A-80BC	MB846C or MB846A	YES
Cosmic 20E (FE20C)	20 lbs.	33.5 lbs.	7-1/2"	21-1/4"	8-3/4"	1.0 cu.ft.	10A-120BC	MB811C	YES
Cosmic 20E (FE20A)	20 lbs.	38 lbs.	7"	24"	10-1/4"	1.0 cu.ft.	10A-120B	MB810A	YES
495	50 lbs	174 lbs	--	46"	21-1/2"	--	30A-160BC	---	--
Sentinel 5	5 lbs.	14 lbs.	5-1/4"	17-3/4"	8-1/4"	.65 cu.ft.	5BC	MB809C or MB809A	YES
Sentinel 10	10 lbs.	28.25 lbs.	7"	24"	12"	1.3 cu.ft.	10BC	MB810C or MB810A	YES
Sentinel 15	15 lbs.	37.75 lbs.	7"	30"	12"	1.0 cu.ft.	10BC	MB810C or MB864A	YES
Sentinel 20	20 lbs.	50.75 lbs.	8"	30"	13"	2.1 cu.ft.	10BC	MB811C or MB811A	YES
Galaxy 2-1/2*	2-1/2 lbs.	5.5 lbs.	3-3/8"	15-1/2"	5-3/4"	.2 cu.ft.	10BC	MB817C or MB817A*	YES
Galaxy 5	5 lbs.	9.25 lbs.	4-1/4"	15-1/4"	5-1/2"	.35 cu.ft.	10BC	MB818A	YES
Galaxy 5-1/2	5-1/2 lbs.	10.5 lbs.	4-1/4"	16-3/8"	7-1/4"	.4 cu.ft.	40BC	MB818C or MB818A	YES
Galaxy 6	6 lbs.	13.75 lbs.	5"	16-1/4"	8-1/2"	.5 cu.ft.	40BC	MB808A	YES
Galaxy 10	10 lbs.	18.25 lbs.	5-1/8"	21"	7-3/4"	.65 cu.ft.	40BC or 60BC	MB846C or MB846A	YES
Galaxy 20	20 lbs.	38 lbs.	7-1/2"	23-1/4"	10-1/4"	1.0 cu.ft.	120BC	MB810C or MB810A	YES
496	50 lbs.	174 lbs.	--	46"	21-1/2"	--	160BC	--	--
Mercury 2-1/2*	2-1/2 lbs	5.25 lbs	3-3/8"	15-1/2"	6-3/8"	.25 cu.ft.	2BC	MB817C or MB817A*	N/A
Mercury 5	5 lbs	9.5 lbs	4-1/4"	16-3/8"	7-1/4"	.3 cu.ft.	5BC	MB818C or MB818A	YES
Mercury 11 (FM11C)	11 lbs	21.25 lbs	7"	17-1/2"	8-5/8"	1.0 cu.ft.	1A-10BC	MB810C	YES
Mercury 11 (FM11A)	11 lbs	22.5 lbs	6"	21-7/8"	9-1/4"	1.0 cu.ft.	1A-10BC	MB812A	YES
Mercury 15-1/2 (FM15C)	15-1/2 lbs	25.75 lbs	7"	17-1/2"	8-5/8"	1.0 cu.ft.	2A-10BC	MB810C	YES
Mercury 15-1/2 (FM15A)	15-1/2 lbs	27.5 lbs	6"	21-7/8"	9-1/4"	1.0 cu.ft.	2A-10BC	MB812A	YES
Saturn 15	1.8 gal	22.5 lbs	7"	19-1/4"	9"	.9 cu.ft.	Class K	MB810C or MB810A	--
Saturn 25	2.5 gal	33.5 lbs.	7"	24-1/2"	9"	1.1 cu.ft.	Class K	MB810C or MB810A	--
272	2.5 gal	8 lbs. «	7"	28"	14"	1.3 cu ft.	2AC	14315	--

Dimensions in Inches

*INDICATES MARK BRACKET STANDARD. J HOOK WALL BRACKET STANDARD WITH ALL OTHER EXTINGUISHERS.
 NOTE: JL EXTINGUISHERS ARE SHIPPED FULLY CHARGED WITH THE EXCEPTION OF THE GRENADIER & 272. NFPA REGULATIONS ALSO REQUIRE EXTINGUISHERS TO BE INSPECTED WHEN INITIALLY PLACED IN SERVICE AND ALL LOCAL FIRE CODE AND ALL LOCAL FIRE CODE AND TAGGING REQUIREMENTS MUST BE ADHERED TO. ALL FIRE EXTINGUISHER SIZES ARE NOMINAL.

FIRE EXTINGUISHER CABINETS

AMBASSADOR SERIES: Steel Trim and Door

Door and Trim Construction: Cold rolled steel with white powder-coat finish standard. Flush cabinet doors with a 5/8" door stop are attached by a continuous hinge and equipped with zinc-plated handle and roller catch.

Trim Style and Depth: Recessed - 3/8" flat trim or trimless. Semi-Recessed - 1 1/4", 1 1/2" Square Edge or 2 1/2", 3", 4" (recessed pull), 4 1/2" Rolled Edge. Surface-mount has a square edge or optional rolled edge upon request. 1 3/4" face trim on frame and door.

Tub: Constructed of cold rolled steel with white powder-coat finish standard.

Options at Additional Cost: Color door and trim or tub. Rolled Edge Surface Mount Cabinet. See page 24. Custom colors.

Fire-Rated Option Available: Yes



AMBASSADOR
1017F10 with Optional
Lettering (BLK OPTION)



AMBASSADOR
1013F10

ACADEMY SERIES: Aluminum Trim and Door

Door and Trim Construction: Clear anodized aluminum. Flush cabinet doors with a 5/8" door stop are attached by a continuous hinge and equipped with zinc-plated handle and roller catch.

Trim Style and Depth: Recessed - 3/8" flat trim. Semi-Recessed - 1 1/4", 1 1/2" Square Edge or 2 1/2", 3", 4" (recessed pull), 4 1/2" Rolled Edge. Surface-mount has a square edge. 1 3/4" face trim on frame and door.

Tub: Constructed of cold rolled steel with white powder-coat finish standard. Surface-mounted models have clear anodized aluminum tubs.

Options at Additional Cost: Light, medium or dark bronze anodized finish. See page 24. Aluminum tub for non-rated use (#180 clear anodized).

Fire-Rated Option Available: Yes



ACADEMY
1027V10 (DK BRONZE OPTION)



ACADEMY
C1027V10

COSMOPOLITAN SERIES: Stainless Steel Trim and Door

Door and Trim Construction: No. 4 Stainless Steel Trim and Door. Flush cabinet doors with a 5/8" door stop are attached by a continuous hinge and equipped with zinc-plated handle and roller catch.

Trim Style and Depth: Recessed - 3/8" flat trim. Semi-Recessed - 1 1/4", 1 1/2" Square Edge or 2 1/2", 3", 4" (recessed pull), 4 1/2" Rolled Edge. Surface-mount has a square edge or optional rolled edge upon request. 1 3/4" face trim on frame and door.

Tub: Constructed of cold rolled steel with white powder-coat finish standard. Surface-mounted models have No 4 stainless tubs.

Options at Additional Cost: Custom stainless finishes - #6 satin, #7 polished, #8 mirror. Stainless tub with #4 finish. Rolled Edge Surface Mount Cabinet.

Fire-Rated Option Available: Yes



COSMOPOLITAN
1036F16 (POLISHED #7)



COSMOPOLITAN
1035S21

CABINET OPTIONS FOR ALL MODELS: AMBASSADOR, ACADEMY & COSMOPOLITAN

Door Styles w/pull

F	Full Glazing
G	Full Glazing & SAF-T-LOK™
D	Horizontal Duo Panel
E	Horizontal Duo Panel & SAF-T-LOK™
S21	Solid
L22	Solid with SAF-T-LOK™
L24	Solid with Cylinder Lock & No Handle
B	Solid with 2" x 4" Acrylic Insert & SAF-T-LOK™
V	Vertical Duo
W	Vertical Duo & SAF-T-LOK™

Door Glazing

10	Clear Acrylic
13	Clear Wire Glass
15	Bronze Acrylic
16	Gray Acrylic
17	Clear Tempered Glass
18	Laminated Safety Glass

Options at Additional Cost

Vertical or Horizontal Lettering - See Page 21
 Futura Embossed "Fire" Handle in Mill, White or Red
 ADA Flush Pull or Chrome Turn Handle
 Wall Signs & Alarms - See Page 20
 Red or Black Painted Steel Tub
 Engraved Metal Door or Etched Glass

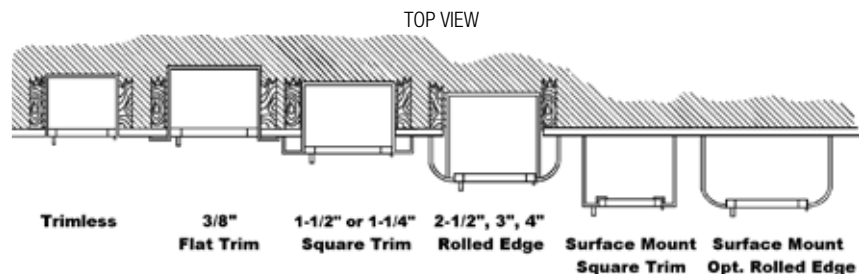

FIRE EXTINGUISHER CABINETS



AMBASSADOR, ACADEMY, COSMOPOLITAN: Door Styles

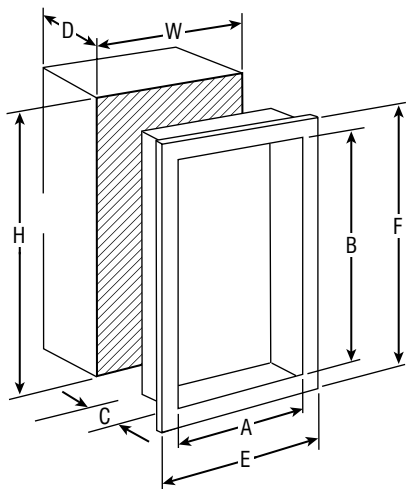

SELECTION CHART FOR AMBASSADOR, ACADEMY, COSMOPOLITAN SERIES

Trim and Door Material and Series #			Tub I.D.			Frame O.D.			Wall Opening: Non-rated			Wall Opening: FX Option			Accommodates Following Extinguishers
Steel	Aluminum	Stainless Steel	Trim Style	A	B	C	E	F	W	H	D	W	H	D	
AMBASSADOR	ACADEMY	COSMOPOLITAN		Width	Height	Depth									
8114	--	--	Trimless	9	18	5 1/2	9 1/4	18 1/4	9 1/2	18 1/2	5 3/4	--	--	--	Cosmic & Galaxy 2.5-6, Mercury 2.5-5
8115	8125	8135	Flat Trim	9	18	5 1/2	12 3/8	21 3/8	10	19	5 1/2	11	20 1/8	6 3/8	
8116	8126	8136	1 1/2" Square	9	18	5 1/2	12 3/8	21 3/8	10	19	4	11	20 1/8	4 7/8	
8117	8127	8137	2 1/2" Rolled	9	18	5 1/2	12 3/8	21 3/8	10	19	3 1/8*	11	20 1/8	4*	
8113	8123	8133	Surf. Mtd.	12 3/16	21 3/16	6	12 3/8	21 3/8	--	--	--	--	--	--	
1710	1720	1730	2 1/4" Square	10 1/2	24	5	13 7/8	27 3/8	11 1/2	25	2 3/4	12 1/2	26 1/8	3 5/8	Cosmic & Galaxy 2.5-10, Mercury 2.5 & 5 (10 lb exting. must be mounted on back)
1815	1825	1835	Flat Trim	10 1/2	24	5 1/2	13 7/8	27 3/8	11 1/2	25	5 1/2	12 1/2	26 1/8	6 3/8	
1816	1826	1836	1 1/2" Square	10 1/2	24	5 1/2	13 7/8	27 3/8	11 1/2	25	4	12 1/2	26 1/8	4 7/8	
1817	1827	1837	3" Rolled	10 1/2	24	5 1/2	13 7/8	27 3/8	11 1/2	25	2 5/8	12 1/2	26 1/8	3 1/2	
1812	1822	1832	4" Rolled	10 1/2	24	5 1/2	13 7/8	27 3/8	11 1/2	25	1 5/8*	12 1/2	26 1/8	2 1/2*	
1818	1828	1838	4 1/2" Rolled	10 1/2	24	5 1/2	13 7/8	27 3/8	11 1/2	25	1 1/8*	12 1/2	26 1/8	2*	
1014	--	--	Trimless	10 1/2	24	6	13 3/4	24 1/4	11	24 1/2	6 1/4	-	-	-	Cosmic & Galaxy 2.5-10, Mercury 2.5 & 5, Sentinel 5
1015	1025	1035	Flat Trim	10 1/2	24	6	13 7/8	27 3/8	11 1/2	25	6	12 1/2	26 1/8	6 7/8	
1016	1026	1036	1 1/2" Square	10 1/2	24	6	13 7/8	27 3/8	11 1/2	25	4 5/8	12 1/2	26 1/8	5 3/8	
1017	1027	1037	3" Rolled	10 1/2	24	6	13 7/8	27 3/8	11 1/2	25	3 1/8	12 1/2	26 1/8	4	
1012	1022	1032	4" Rolled	10 1/2	24	6	13 7/8	27 3/8	11 1/2	25	2 1/8*	12 1/2	26 1/8	3*	
1018	1028	1038	4 1/2" Rolled	10 1/2	24	6	13 7/8	27 3/8	11 1/2	25	1 5/8*	12 1/2	26 1/8	2 1/2*	
1013	1023	1033	Surf. Mtd.	13 11/16	27 3/16	6 1/2	13 7/8	27 3/8	--	--	--	--	--	--	
2014	--	--	Trimless	12	27	7 3/4	12 1/4	27 1/4	12 1/2	27 1/2	8	--	--	--	Any Cosmic**, Galaxy**, Mercury, Saturn or Grenadier P, Sentinel 5 & 10
2015	2025	2035	Flat Trim	12	27	7 3/4	15 3/8	30 3/8	13	28	7 3/4	14	29 1/8	8 1/2	
2016	2026	2036	1 1/4" Square	12	27	7 3/4	15 3/8	30 3/8	13	28	6 3/4	14	29 1/8	7 3/8	
2017	2027	2037	2 1/2" Rolled	12	27	7 3/4	15 3/8	30 3/8	13	28	5 1/2*	14	29 1/8	6 3/8*	
2012	2022	2032	4" Rolled	12	27	7 3/4	15 3/8	30 3/8	13	28	4*	14	29 1/8	4 5/8*	
2018	2028	2038	4 1/2" Rolled	12	27	7 3/4	15 3/8	30 3/8	13	28	3 1/2*	14	29 1/8	4 1/8*	
2013	2023	2033	Surf. Mtd.	15 3/16	30 3/16	8 1/4	15 3/8	30 3/8	--	--	--	--	--	--	
3015	3025	3035	Flat Trim	16	32	7 3/4	19 3/8	35 3/8	17	33	7 3/4	18	34 1/8	8 1/2	Any Cosmic**, Galaxy**, Mercury, Saturn or Grenadier P, Sentinel 5 & 10 & 15, 272
3016	3026	3036	1 1/4" Square	16	32	7 3/4	19 3/8	35 3/8	17	33	6 3/4	18	34 1/8	7 3/8	
3017	3027	3037	2 1/2" Rolled	16	32	7 3/4	19 3/8	35 3/8	17	33	5 1/2*	18	34 1/8	6 3/8*	
3012	3022	3032	4" Rolled	16	32	7 3/4	19 3/8	35 3/8	17	33	4*	18	34 1/8	4 5/8*	
3018	3028	3038	4 1/2" Rolled	16	32	7 3/4	19 3/8	35 3/8	17	33	3 1/2*	18	34 1/8	4 1/8*	
3013	3023	3033	Surf. Mtd.	19 3/16	35 3/16	8 1/4	19 3/8	35 3/8	--	--	--	--	--	--	
4015	4025	4035	Flat Trim	20	27	7 3/4	23 3/8	30 3/8	21	28	7 3/4	22	29 1/8	8 1/2	Two Each of Any Cosmic**, Galaxy**, Mercury, Saturn or Grenadier P, Sentinel 5
4016	4026	4036	1 1/4" Square	20	27	7 3/4	23 3/8	30 3/8	21	28	6 3/4	22	29 1/8	7 3/8	
4017	4027	4037	2 1/2" Rolled	20	27	7 3/4	23 3/8	30 3/8	21	28	5 1/2*	22	29 1/8	6 3/8*	
4012	4022	4032	4" Rolled	20	27	7 3/4	23 3/8	30 3/8	21	28	4*	22	29 1/8	4 5/8*	
4018	4028	4038	4 1/2" Rolled	20	27	7 3/4	23 3/8	30 3/8	21	28	3 1/2*	22	29 1/8	4 1/8*	
4013	4023	4033	Surf. Mtd.	23 3/16	30 3/16	8 1/4	23 3/8	30 3/8	--	--	--	--	--	--	

Dimensions in Inches

*ADD 5/8" FOR CABINETS WITH ALUMINUM FRAMES.

**COSMIC 20 & GALAXY 20 EXTINGUISHER MUST BE MOUNTED ON THE BACK OF THE CABINET TUB.

FIRE EXTINGUISHER CABINETS

PANORAMA SERIES: Frameless Acrylic Door

Door and Trim Construction: The Panorama features a frameless acrylic door of clear or opaque textured acrylic. The "stippled" texture of the opaque doors and exclusive aluminum backing protect the lettering, which is available in 3 colors and configurations. Clear doors also available. Flush cabinet doors are attached by a continuous hinge and equipped with zinc-plated handle and roller catch. Trim is cold rolled steel with white powder-coat, clear anodized aluminum, or #4 stainless steel.

Trim Style and Depth: Recessed - 3/8" flat trim or trimless. Semi-Recessed - 1 1/4", 1 1/2" Square Edge or 2 1/2", 3", 4" (recessed pull), 4 1/2" Rolled Edge. Surface-mount has a square edge or optional rolled edge for steel or stainless steel upon request. 1 3/4" face trim on frame. See page 6.

Tub: Constructed of cold rolled steel with white powder-coat finish standard.

Fire-Rated Option Available: Yes

Door Styles w/pull

- C70 Clear 3/16" Unlettered Smooth Acrylic
- C71 Clear 3/16" Unlettered Smooth Acrylic with SAF-T-LOK™
- P Identity: 3/16" Textured Obscure Acrylic with Lettering
- Q Identity: 3/16" Textured Obscure Acrylic with Lettering & SAF-T-LOK™

Door Glazing

- 40 V, Black Bkgd, White Lettering
- 41 V, Red Bkgd, White Lettering
- 42 V, White Bkgd, Black Lettering
- 43 V, White Bkgd, Red Lettering
- 45 H, Black Bkgd, White Lettering
- 46 H, Red Bkgd, White Lettering
- 47 H, White Bkgd, Black Lettering
- 48 H, White Bkgd, Red Lettering
- 50 Ascend, Black Bkgd, White Lettering
- 51 Ascend, Red Bkgd, White Lettering
- 52 Ascend, White Bkgd, Black Lettering
- 53 Ascend, White Bkgd, Red Lettering



PANORAMA 1036C70 W/COSMIC 10E



PANORAMA 1012P48 ADAC OPTION

Options at Additional Cost

Futura Pull, ADA Flush Pull, Other Color Tub, Wall Signs & Alarms - Page 21

SELECTION CHART FOR PANORAMA SERIES

Trim and Door Material and Series #				Tub I.D.			Frame O.D.		Wall Opening: Non-rated			Wall Opening: FX Option			Accommodates Following Extinguishers
Steel	Aluminum	Stainless Steel	Trim Style	A	B	C	E	F	W	H	D	W	H	D	
8114	--	--	Trimless	9	18	5 1/2	9 1/4	18 1/4	9 1/2	18 1/2	5 3/4	--	--	--	Cosmic & Galaxy 2.5-6, Mercury 2.5-5
8115	8125	8135	Flat Trim	9	18	5 3/4	12 3/8	21 3/8	10	19	5 3/4	11	20 1/8	6 3/8	
8116	8126	8136	1 1/2" Square	9	18	5 1/2	12 3/8	21 3/8	10	19	4	11	20 1/8	4 7/8	
8117	8127	8137	2 1/2" Rolled	9	18	5 1/2	12 3/8	21 3/8	10	19	3 1/8*	11	20 1/8	4*	
8113	8123	8133	Surf. Mtd.	12 3/16	21 3/16	6	12 3/8	21 3/8	--	--	--	--	--	--	
1815	1825	1835	Flat Trim	10 1/2	24	5 3/4	13 7/8	27 3/8	11 1/2	25	5 3/4	12 1/2	26 1/8	6 3/8	Cosmic & Galaxy 2.5-6, (10 lb if mounted on back)
1816	1826	1836	1 1/2" Square	10 1/2	24	5 1/2	13 7/8	27 3/8	11 1/2	25	4	12 1/2	26 1/8	4 7/8	
1817	1827	1837	3" Rolled	10 1/2	24	5 1/2	13 7/8	27 3/8	11 1/2	25	2 5/8	12 1/2	26 1/8	3 1/2	
1812	1822	1832	4" Rolled	10 1/2	24	5 1/2	13 7/8	27 3/8	11 1/2	25	1 5/8*	12 1/2	26 1/8	2 1/2*	
1818	1828	1838	4 1/2" Rolled	10 1/2	24	5 1/2	13 7/8	27 3/8	11 1/2	25	1 1/8*	12 1/2	26 1/8	2*	
1014	--	--	Trimless	10 1/2	24	6	10 3/4	24 1/4	11	24 1/2	6 1/4	--	--	--	Mercury 2.5 & 5
1015	1025	1035	Flat Trim	10 1/2	24	6	13 7/8	27 3/8	11 1/2	25	6	12 1/2	26 1/8	6 7/8	
1016	1026	1036	1 1/2" Square	10 1/2	24	6	13 7/8	27 3/8	11 1/2	25	4 5/8	12 1/2	26 1/8	5 3/8	
1017	1027	1037	3" Rolled	10 1/2	24	6	13 7/8	27 3/8	11 1/2	25	3 1/8	12 1/2	26 1/8	4	
1012	1022	1032	4" Rolled	10 1/2	24	6	13 7/8	27 3/8	11 1/2	25	2 1/8*	12 1/2	26 1/8	3*	
1018	1028	1038	4 1/2" Rolled	10 1/2	24	6	13 7/8	27 3/8	11 1/2	25	1 5/8*	12 1/2	26 1/8	2 1/2*	
1013	1023	1033	Surf. Mtd.	13 11/16	27 3/16	6 1/2	13 7/8	27 3/8	--	--	--	--	--	--	
2014	--	--	Trimless	12	27	7 3/4	12 1/4	27 1/4	12 1/2	27 1/2	8	--	--	--	Any Cosmic**, Galaxy**, Mercury, Saturn or Grenadier P, Sentinel 5 & 10
2015	2025	2035	Flat Trim	12	27	7 3/4	15 3/8	30 3/8	13	28	7 3/4	14	29 1/8	8 1/2	
2016	2026	2036	1 1/4" Square	12	27	7 3/4	15 3/8	30 3/8	13	28	6 3/4	14	29 1/8	7 3/8	
2017	2027	2037	2 1/2" Rolled	12	27	7 3/4	15 3/8	30 3/8	13	28	5 1/2*	14	29 1/8	6 3/8*	
2012	2022	2032	4" Rolled	12	27	7 3/4	15 3/8	30 3/8	13	28	4*	14	29 1/8	4 5/8*	
2018	2028	2038	4 1/2" Rolled	12	27	7 3/4	15 3/8	30 3/8	13	28	3 1/2*	14	29 1/8	4 1/8*	
2013	2023	2033	Surf. Mtd.	15 3/16	30 3/16	8 1/4	15 3/8	30 3/8	--	--	--	--	--	--	
3015	3025	3035	Flat Trim	16	32	7 3/4	19 3/8	35 3/8	17	33	7 3/4	18	34 1/8	8 1/2	Any Cosmic**, Galaxy**, Mercury, Saturn or Grenadier P, Sentinel 5 & 10 & 15, 272
3016	3026	3036	1 1/4" Square	16	32	7 3/4	19 3/8	35 3/8	17	33	6 3/4	18	34 1/8	7 3/8	
3017	3027	3037	2 1/2" Rolled	16	32	7 3/4	19 3/8	35 3/8	17	33	5 1/2*	18	34 1/8	6 3/8*	
3012	3022	3032	4" Rolled	16	32	7 3/4	19 3/8	35 3/8	17	33	4*	18	34 1/8	4 5/8*	
3018	3028	3038	4 1/2" Rolled	16	32	7 3/4	19 3/8	35 3/8	17	33	3 1/2*	18	34 1/8	4 1/8*	
3013	3023	3033	Surf. Mtd.	19 3/16	35 3/16	8 1/4	19 3/8	35 3/8	--	--	--	--	--	--	
4015	4025	4035	Flat Trim	20	27	7 3/4	23 3/8	30 3/8	21	28	7 3/4	22	29 1/8	8 1/2	Two Each of Any Cosmic**, Galaxy**, Mercury, Saturn or Grenadier P, Sentinel 5
4016	4026	4036	1 1/4" Square	20	27	7 3/4	23 3/8	30 3/8	21	28	6 3/4	22	29 1/8	7 3/8	
4017	4027	4037	2 1/2" Rolled	20	27	7 3/4	23 3/8	30 3/8	21	28	5 1/2*	22	29 1/8	6 3/8*	
4012	4022	4032	4" Rolled	20	27	7 3/4	23 3/8	30 3/8	21	28	4*	22	29 1/8	4 5/8*	
4018	4028	4038	4 1/2" Rolled	20	27	7 3/4	23 3/8	30 3/8	21	28	3 1/2*	22	29 1/8	4 1/8*	
4013	4023	4033	Surf. Mtd.	23 3/16	30 3/16	8 1/4	23 3/8	30 3/8	--	--	--	--	--	--	

Dimensions in Inches

*ADD 5/8" FOR CABINETS WITH ALUMINUM FRAMES.

**COSMIC 20 & GALAXY 20 EXTINGUISHER MUST BE MOUNTED ON THE BACK OF THE CABINET TUB.

FIRE EXTINGUISHER CABINETS

CLEAR VU SERIES: Acrylic Bubble Cabinet in Aluminum, Steel, Stainless, Bronze or Brass



Door and Trim Construction: US10 satin bronze, US3 polished brass, clear anodized aluminum, #4 stainless steel or CRS with white powder coat finish. Flush cabinet doors with a 5/8" door stop are attached by a continuous hinge and equipped with zinc-plated handle and roller catch.

Bubble: Acrylic bubble allows 180° extinguisher visibility. 2 1/2" projection.

Trim Style and Depth: Recessed - 3/8" flat trim, Semi-Recessed - 1 1/4", 1 1/2" Square Edge and 2 1/2" or, 3" Rolled Edge. Surface-mount has a square edge or optional rolled edge for steel or stainless steel upon request. 1 3/4" face trim on frame and door.

Tub: Constructed of cold rolled steel with white powder-coat finish standard. Extinguisher must be mounted to back of tub using bracket.



Door Styles

- F Full Acrylic w/pull
- G Full Acrylic with SAF-T-LOK™

Bubble

- 25 Clear Acrylic
- 26 Red Acrylic
- 27 Bronze Acrylic

Options at Additional Cost

- Aluminum Tub for Aluminum Cabinets Only (Non-Rated Use)
- Color Painted Tub (Red or Black)
- Color Anodized Aluminum – Light, Medium or Dark
- Vertical or Horizontal Lettering. See Page 21.
- FIRE-FX Fire-Rated Tub Option
- Futura Embossed "Fire" Handle - Mill or White
- US 9 Bright Polished Bronze
- US 4 Satin Brass
- US 10B Dark Oxidized Oil-Rubbed Bronze
- Wall Signs and Alarms. See Page 20

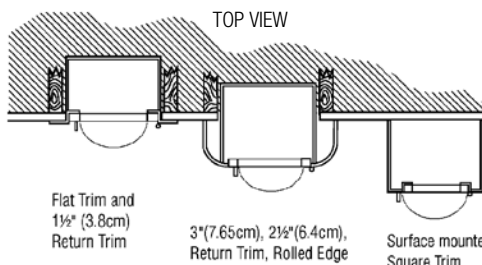

Door Material and Series #					Trim Style	Tub I.D.			Frame O.D.		Wall Opening: Non-Rated			Wall Opening: FX Option			Accommodates Following Extinguishers
Steel	Aluminum*	Stainless Steel	Bronze	Brass		A	B	C	E	F	W	H	D	W	H	D	
1515	1525	1535	1545	1555	Flat Trim	10 1/2	24	4	13 7/8	27 3/8	11 1/2	25	4	12 1/2	26 1/8	4 7/8	Cosmic & Galaxy 2.5-10, Mercury 2.5-5, Sentinel 5
1516	1526	1536	1546	1556	1 1/2" Square	10 1/2	24	4	13 7/8	27 3/8	11 1/2	25	2 5/8	12 1/2	26 1/8	3 1/2	
1517	1527	1537	1547	1557	3" Rolled	10 1/2	24	4	13 7/8	27 3/8	11 1/2	25	1 1/8	12 1/2	26 1/8	2	
1513	1523	1533	1543	1553	Surf. Mtd.	13 11/16	27 3/16	4 5/8*	13 7/8	27 3/8	--	--	--	--	--	--	Cosmic & Galaxy 2.5-10, Mercury 2.5-15 (FM11A & 15A), Sentinel 5, Saturn 15-25
2515	2525	2535	2545	2555	Flat Trim	14	30	4	17 3/8	33 3/8	15	31	4	16	32 1/8	4 7/8	
2516	2526	2536	2546	2556	1 1/4" Square	14	30	4	17 3/8	33 3/8	15	31	2 7/8	16	32 1/8	3 3/4	
2517	2527*	2537	--	--	2 1/2" Rolled	14	30	4	17 3/8	33 3/8	15	31	1	16	32 1/8	2 1/2*	
2513	2523	2533	2543	2553	Surf. Mtd.	17 3/16	33 3/16	4 5/8	17 3/8	33 3/8	--	--	--	--	--	--	Two each Cosmic & Galaxy 2.5-10, Mercury 2.5-15 (FM11A & 15A), Sentinel 5
4515	4525	4535	--	--	Flat Trim Double Door	28	30	4	31 3/8	33 3/8	29	31	4	30	32 1/8	4 7/8	
4513	4523	4533	--	--	Surf. Mtd. Double Door	31 3/16	33 3/16	4 5/8	31 3/8	33 3/8	--	--	--	--	--	--	

Dimensions in Inches

*ADD 5/8" TO WALL DEPTH FOR A CABINET WITH AN ALUMINUM FRAME. 4500 SERIES CONSIST OF A DOUBLE DOOR DESIGN.

SMB SERIES: Surface-Mounted Acrylic Bubble and Steel Cabinet



Door and Trim Construction: Cold rolled steel with six standard powder-coated colors to choose from - black, white, red, bronze, silver or gray hammertone. Flush cabinet doors with a 5/8" door stop are attached by a continuous hinge and equipped with zinc-plated handle and roller catch. Custom powder-coat finishes available upon request. See page 24.

Bubble: Acrylic bubble allows 180° extinguisher visibility. 2-1/2" projection.

Trim Style and Depth: This surface-mounted cabinet has a 3" rolled edge that forms a tub. 3" deep tub constructed of cold rolled steel with white powder-coat finish standard.

Extinguisher: Extinguisher must be mounted to back of tub using bracket.

Fire-Rated Option Available: No

Options at Additional Cost: Vertical or Horizontal Lettering. See Page 21.



Door Finishes

- BK Black
- W White
- R Red
- GH Gray Hammertone
- B Bronze
- BRA Brass
- SA Silver

Door Glazing

- 25 Clear Acrylic
- 26 Red Acrylic
- 27 Bronze Acrylic

Model							Frame Inside Dimensions	Frame Outside Dimensions	Accommodates Following Extinguishers
White	Hammertone	Brass	Bronze	Silver	Red	Black			
SMB-W	SMB-GH	SMB-BRA	SMB-B	SMB-SA	SMB-R	SMB-BK	13 13/16 x 27 5/16	13 15/16 x 27 7/16	Cosmic & Galaxy 2.5-10, Mercury 2.5-5

Dimensions in Inches

FIRE EXTINGUISHER CABINETS

EMBASSY SERIES: Decorative Trimless Recessed Cabinet

Door and Trim Construction: These 7/8" formed design cabinet doors are available in # 4 satin stainless steel, US 10 satin bronze, US 3 polished brass, clear anodized aluminum or or white powder coated steel. Doors feature two concealed hinges and concealed handle and roller catch.

Trim Style and Depth: None

Tub: Constructed of cold rolled steel with white powder-coat finish standard.

Unique Options: The 5900 Series is equipped with a shelf 12" from the bottom. Knockouts are located 6" from the bottom and 4 1/4" from the back on both the right- and left-hand sides.

Fire-Rated Option Available: Yes

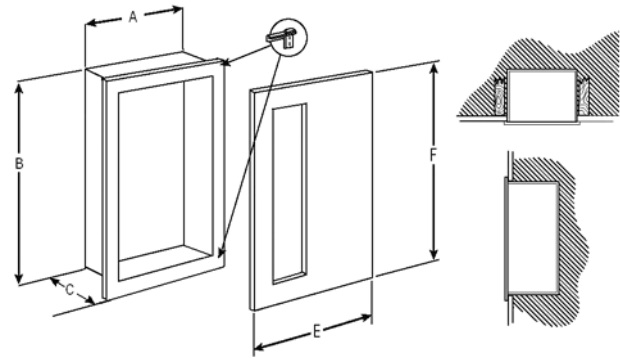

Door Styles

- S21 Solid (concealed pull)
- V Vertical Duo (concealed pull)
- W Vertical Duo with SAF-T-LOK™ and Pull Handle
- L22 Solid with SAF-T-LOK™ and Pull Handle

Door Glazing

- 10 Clear Acrylic
- 13 Clear Wire Glass
- 15 Bronze Acrylic
- 16 Gray Acrylic
- 17 Clear Tempered Glass
- 18 Laminated Safety Glass

Options at Additional Cost

- Color Painted Door or Tub - Steel Only Vertical or Horizontal Lettering. See Page 21 FIRE-FX
- Fire-Rated Tub Option
- Futura Embossed "Fire" Handle - Mill or White
- Wall Signs and Alarms, See Page 20
- Color Anodized Aluminum, See Page 24
- Color Anodized Aluminum, See Page 24
- #6 Satin, #7 Polished, #8 Mirror Stainless
- US9 Polished Bronze Door - Clear Coated
- US10B Oil-Rubbed Bronze Door
- US4 Satin Brass Door - Clear Coated
- Etched Lettering in Glass
- Engraved Lettering in Metal

Door Material and Series #					Tub I.D.			Door O.D.*		Wall Opening: Non-Rated			Wall Opening: FX Option			Accommodates Following Extinguishers
Steel	Aluminum	Stainless Steel	Bronze	Brass	A	B	C	E	F	W	H	D	W	H	D	
5614	5624	5634	5644	5654	10 1/2	24	5-3/4	12 3/4 13 3/4 FX	26 1/4 27 1/4 FX	11 1/2	25	6	12 1/2	26 1/8	6 7/8	Cosmic & Galaxy 2.5-10, Mercury 2.5-5, Sentinel 5
5714	5724	5734	5744	5754	16	32	7 3/4	18 1/4 19 1/4 FX	34 1/4 35 1/4 FX	17	33	8	18	34 1/8	8 7/8	Any Cosmic*, Galaxy, Mercury, Saturn or Grenadier P, Sentinel 5-15, 272
Fire Department Valve, Hose & Extinguisher Cabinets																
5514	5524	5534	5544	5554	18	18	7 3/4	20 1/4 21 1/4 FX	20 1/4 21 1/4 FX	19	19	8	20	20 1/8	8 7/8	1-1/2" or 2-1/2" Fire Department Valve Left & Right K.O.'s 9" from top, 4" from back** N/A F.R. Cabinets
5814	5824	5834	--	--	32	32	7 3/4	34 1/4	34 1/4	33	33	8	--	--	--	1-1/2" or 2-1/2" Rack Unit & 2-1/2" Fire Department Valve or Extinguisher. 2 Left K.O. 4" from back, top & bottom.
5914	5924	5934	5944	5954	16	40	8 3/4	18 1/4 19 1/4 FX	42 1/4 43 1/4 FX	17	41	9	18	42 1/8	9 7/8	2-1/2" Fire Department Valve & Fire Extinguisher Any Cosmic, Galaxy, Mercury, Saturn or Grenadier P, Sentinel 5 & 10

Dimensions in Inches

*COSMIC & GALAXY 20 EXTINGUISHER MUST BE MOUNTED ON THE BACK OF THE CABINET TUB.

**KNOCKOUTS N/A STAINLESS TUBS

ALL MODELS SHOWN ON THIS PAGE ARE ADAC-COMPLIANT



CAVALIER SERIES: Decorative Bronze or Brass Cabinet

Door and Trim Construction: Standard finishes are US10 satin bronze or US3 polished brass. Flush cabinet doors with a 5/8" door stop are attached by a continuous hinge and equipped with zinc-plated handle and roller catch.

Trim Style and Depth: Recessed - 3/8" flat trim. Semi-Recessed - 1 1/4", 1 1/2" Square Edge or 3" Rolled Edge. Surface-mount has a square edge. 1 3/4" face trim on frame and door.

Tub: Constructed of cold rolled steel with white powder-coat finish standard. Surface mounted models have brass or bronze tubs.

Unique Options: Large selection of Bronze and Brass finishes.

Fire-Rated Option Available: Yes

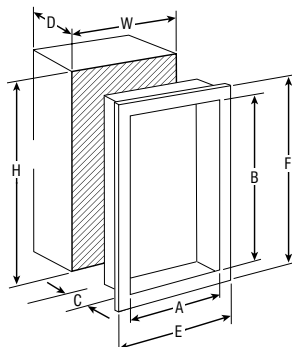

1845W10



1045 WITH CUSTOM US10B FINISH & ENGRAVED/FILLED LETTERING

Door Styles w/pull

- F Full Glazing
- G Full Glazing & SAF-T-LOK™
- D Horizontal Duo Panel
- E Horizontal Duo Panel & SAF-T-LOK™
- S21 Solid
- L22 Solid with SAF-T-LOK™
- L24 Solid with Cylinder Lock & No Handle
- B10 Solid with 2" x 4" Acrylic Insert & SAF-T-LOK™
- V Vertical Duo
- W Vertical Duo & SAF-T-LOK™

Door Glazing

- 10 Clear Acrylic
- 13 Clear Wire Glass
- 15 Bronze Acrylic
- 16 Gray Acrylic
- 17 Clear Tempered Glass
- 18 Laminated Safety Glass



1047S21



1857V10

Options at Additional Cost

- Vertical or Horizontal Lettering - See Page 21
- Futura Embossed "Fire" Handle in Mill, White or Red
- Pulls - ADA, Bronze, Brass. See page 20
- Fire-FX® Fire-Rated Tub Option
- Wall Signs, Labels & Alarms- See Page 20
- Panorama-Style Full Acrylic Door - See page 8
- Optional Standard Color Frame/Door/Tub - see Page 24
- Optional Color tub - see page 24
- Engraved Metal or Etched Glass Lettering See page 21
- Bronze: US9 Bright Polished, US10B Oil-rubbed Finishes
- Brass: US4 Satin Finish

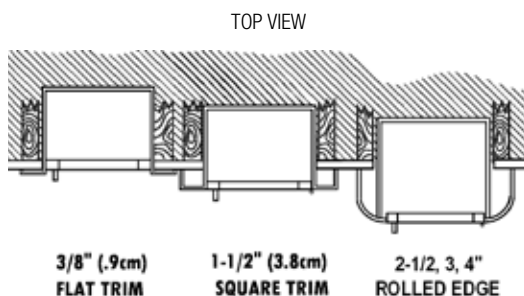

Trim and Door Material and Series #			Tub I.D.		Trim O.D			Wall Opening: Non-Rated			Wall Opening: FX Option			Accommodates Following Extinguishers
Bronze	Brass	Trim Style	A	B	C	E	F	W	H	D	W	H	D	
1845	1855	Flat Trim	10 1/2	24	5 1/2	13 7/8	27 3/8	11 1/2	25	5 1/2	12 1/2	26 1/8	6 3/8	Cosmic & Galaxy 2.5-6, Mercury 2.5 & 5
1846	1856	1 1/2" Square	10 1/2	24	5 1/2	13 7/8	27 3/8	11 1/2	25	4	12 1/2	26 1/8	4 7/8	
1847	1857	3" Rolled	10 1/2	24	5 1/2	13 7/8	27 3/8	11 1/2	25	2 5/8	12 1/2	26 1/8	3 1/2	
1045	1055	Flat Trim	10 1/2	24	6	13 7/8	27 3/8	11 1/2	25	6	12 1/2	26 1/8	6 7/8	Cosmic & Galaxy 2.5-10, Mercury 2.5 & 5, Sentinel 5
1046	1056	1 1/2" Square	10 1/2	24	6	13 7/8	27 3/8	11 1/2	25	4 1/2	12 1/2	26 1/8	5 3/8	
1047	1057	3" Rolled	10 1/2	24	6	13 7/8	27 3/8	11 1/2	25	3 1/8	12 1/2	26 1/8	4	
1043	1053	Surf. Mt.	13 11/16	27 3/16	6 1/2	13 7/8	27 3/8	--	--	--	--	--	--	Any Cosmic*, Galaxy, Mercury, Saturn or Grenadier P, Sentinel 5 & 10
2045	2055	Flat Trim	12	27	7 3/4	15 3/8	30 3/8	13	28	7 3/4	14	29 1/8	8 1/2	
2046	2056	1 1/4" Square	12	27	7 3/4	15 3/8	30 3/8	13	28	6 5/8	14	29 1/8	7 3/8	
2043	2053	Surf. Mt.	15 3/16	30 3/16	8 1/4	15 3/8	30 3/8	--	--	--	--	--	--	

Dimensions in Inches

*COSMIC 20 & GALAXY 20 EXTINGUISHER MUST BE MOUNTED ON THE BACK OF THE CABINET TUB.

FIRE EXTINGUISHER CABINETS

CLASSIC SERIES: Economy Galvanized Fire Extinguisher Cabinets

Tube and Door Frame: White powder-coated galvanized steel or aluminum for rust-resistance with Twin Lock Top.

Door: .060 acrylic front for protection from the elements. Breaker bar standard.

Options at Additional Cost: Have cylinder locks keyed alike for protection, optional colors. Wall signs and labels, See Page 21.

Fire-Rated Option: No



926AZ30
RECESSED MODEL
WITH OPTIONAL
FINISH



9163Z30
SURFACE MOUNT
MODEL

Trim and Door Material New Model#			Previous Model Number	Tub I.D.			Wall Opening			Weight lbs. Each	Master pkg.	Accommodates Following Extinguishers
Gal. Steel	Aluminum	Trim Style		W	H	D	W	H	D			
9163Z30	9123Z30	Surf. Mtd.	99G	8 1/2	19 13/16	6 1/4	--	--	--	7	6	Cosmic & Galaxy 2.5-6, Mercury 2.5-5, Sentinel 5
916AZ20	912AZ30	2 3/4	99GT	8 1/2	19 13/16	6 1/4	9	20 5/16	3 3/4	8	6	
9263Z30	9223Z30	Surf. Mtd.	999G	9 1/2	25 3/4	6 1/4	--	--	--	9	4	Cosmic & Galaxy 2.5-10, Mercury 2.5-5, Sentinel 5
926AZ30	922AZ30	2 3/4	999GT	9 1/2	25 3/4	6 1/4	10	26 1/4	3 3/4	10	4	
936AZ30	932AZ30	4 1/2	104GT	10 1/2	29 3/4	8 1/4	11	30 1/4	4	17	2	Any Cosmic, Galaxy, Mercury, Saturn or Grenadier P, Sentinel 5
9363Z30	9323Z30	Surf. Mtd.	104G	10 1/2	29 3/4	8 1/4	--	--	--	16	2	

SLIDE TRIM WITH LESS THAN 4" EXPOSURE MEETS ADA REQUIREMENTS.

ECONOMYLINE SERIES: Economy Surface-Mounted

Construction: Cold rolled steel tub with gray hammertone powder-coat finish or rust-resistant aluminum.

Door: Sliding .060 clear acrylic front with retainer clip. Breaker bar with chain, pre-drilled holes on top lip for padlock.

Options at Additional Cost: Other colors, brass padlock, Abus padlock. Wall signs and labels, See Page 21.

Fire-Rated Option: No



ECONOMYLINE
5113N20

Trim and Door Material New Model #			Previous Model Number	Tub I.D.			Weight lbs. Each	Master pkg.	Accommodates Following Extinguishers
Steel	Aluminum	Trim Style		W	H	D			
5013N20	5023N20	Surf. Mtd.	818	8 1/8	18	5 1/2	5	6	Cosmic & Galaxy 2.5-6, Mercury 2.5-5
5113N20	5123N20	Surf. Mtd.	924	9 1/8	24	5 1/2	7	4	Cosmic & Galaxy 2.5-10, Mercury 2.5-5, Sentinel 5
5213N20	5223N20	Surf. Mtd.	1028	10 1/8	28	8 1/4	12.5	2	Any Cosmic, Galaxy, Mercury, Saturn or Grenadier P, Sentinel 5

ABS SERIES: Durable, Surface-Mounted ABS Plastic

Construction: The ABS Series is constructed of injection-molded ABS plastic for a dent, rust and corrosion-proof protection for your fire extinguishers. These impact-resistant cabinets include brass lock, cover and labels. Volume discounts available upon request.

Note: The height dimension includes padlock tab.

Fire-Rated Option: No



Model	Tub Size	Cabinet Color	Cover Color	Environment	Accommodates Following Extinguishers
	Height, Width, & Depth				
ABS 16RR	18 1/4 x 8 1/2 x 5 3/8	Red	Red	Indoor/Outdoor	Cosmic & Galaxy 2.5-6, Mercury 2.5-5
ABS 16RC	18 1/4 x 8 1/2 x 5 3/8	Red	Clear	Indoor	
ABS 16WR	18 1/4 x 8 1/2 x 5 3/8	White	Red	Indoor	
ABS 16WC	18 1/4 x 8 1/2 x 5 3/8	White	Clear	Indoor	
ABS 20RR	21 3/4 x 9 5/8 x 6 3/8	Red	Red	Indoor/Outdoor	Cosmic & Galaxy 2.5-10, Mercury 2.5-5, Sentinel 5
ABS 20RC	21 3/4 x 9 5/8 x 6 3/8	Red	Clear	Indoor	
ABS 20WR	21 3/4 x 9 5/8 x 6 3/8	White	Red	Indoor	
ABS 20WC	21 3/4 x 9 5/8 x 6 3/8	White	Clear	Indoor	
ABS 24RR	25 3/4 x 9 5/8 x 6 3/8	Red	Red	Indoor/Outdoor	Cosmic & Galaxy 2.5-10, Mercury 2.5-15 (FMIA & 15A), Sentinel 5
ABS 24RC	25 3/4 x 9 5/8 x 6 3/8	Red	Clear	Indoor	
ABS 24WR	25 3/4 x 9 5/8 x 6 3/8	White	Red	Indoor	
ABS 24WC	25 3/4 x 9 5/8 x 6 3/8	White	Clear	Indoor	

Dimensions in Inches

FIRE EXTINGUISHER CABINETS

DECORLINE SERIES: Economy Steel or Aluminum

The Decorline Series offers an Economical Solution for Interior or Exterior Applications. Select from a wide range of sizes that will fit most 2-1/2-10 lb extinguishers. Choose from 2-1/2", or 4-1/4" Trim or a Surface-mounted Design.



Construction: Cold rolled steel tub with white or gray hammertone powder-coat finish, or aluminum.

Trim: Models with trim feature 2" wide trim in either 2.5" or 4.25" depth, depending on model.

Door: Models with "AN" designation have slide in acrylic front secured by clips and tab for lock at top. All other models have door with continuous hinges and either solid door or door with acrylic window.

Fire-rated Option: No

Options at Additional Cost: Brass or Abus Padlock for "AN" models. Optional colors - See page 24. Wall signs and labels - See page 21.



Trim & Door Material and Series #				Tub I.D.			Frame O.D.		Wall Opening			Accommodates Following Extinguishers	
Steel	Aluminum	Prev. Model	Door Style	Trim Style	W	H	D	W	H	W	H		D
631AN20	--	928X	Slide-in Acrylic Front	2.5" Trim	9 1/8	28	4 1/2	12 1/8	31	9 1/4	28 1/4	2	Cosmic & Galaxy 2.5-5.5, Mercury 2.5-5
501AN20	502AN20	818T	Slide-in Acrylic Front w Breaker Bar	2.5" Trim	8 1/8	18	5 1/2	11 1/8	21	9	19	4	Cosmic & Galaxy 2.5-6, Mercury 2.5-5
511AN20	512AN20	924T		2.5" Trim	9 1/8	24	5 1/2	12 1/8	27	10	25	4	Cosmic & Galaxy 2.5-60, Mercury 2.5-5, Sentinel 5
521AN20	522AN20	1028T		2.5" Trim	10 1/8	28	8 1/4	13 1/8	31	11	29	6	Any Cosmic, Galaxy, Mercury, Saturn & Grenadier P, Sentinel 5
5218N20	5228N20	1028T4		4.25" Trim	10 1/8	28	8 1/4	13 1/8	31	11	29	4 1/4	
5017F20	5027F20	818TDH	Door w/Continuous Hinge, Acrylic Window, Handle	3" Trim	8	17 7/8	5 5/8	11 1/4	21 1/4	9	19	3 1/4	Cosmic & Galaxy 2.5-6, Mercury 2.5-5
5019F20	5029F20	818DH		Surface Mtd.	8	17 7/8	5 5/8	8 1/8	18	--	--	--	
5117F20	5127F20	924TDH		3" Trim	9	23 7/8	5 5/8	12 1/4	27 1/4	10	25	3 1/4	Cosmic & Galaxy 2.5-10, Mercury 2.5-5, Sentinel 5
5119F20	5129F20	924DH		Surface Mtd.	9	23 7/8	5 5/8	9 1/8	24	--	--	--	
5017G20	5027G20	818TDL	Door w/Continuous Hinge, Acrylic Window, Handle, Saf-T-Lok	3" Trim	8	17 7/8	5 5/8	11 1/4	21 1/4	9	19	3 1/4	Cosmic & Galaxy 2.5-6, Mercury 2.5-5
5019G20	5029G20	818DL		Surface Mtd.	8	17 7/8	5 5/8	8 1/8	18	--	--	--	
5117G20	5127G20	924TDL		3" Trim	9	23 7/8	5 5/8	12 1/4	27 1/4	10	25	3 1/4	Cosmic & Galaxy 2.5-10, Mercury 2.5-5, Sentinel 5
5119G20	5129G20	924DL		Surface Mtd.	9	23 7/8	5 5/8	9 1/8	24	--	--	--	
5017S21	5027S21	818TDHS	Solid Door w/Continuous Hinge, Handle	3" Trim	8	17 7/8	5 5/8	11 1/4	21 1/4	9	19	3 1/4	Cosmic & Galaxy 2.5-6, Mercury 2.5-5
5019S21	5029S21	818DHS		Surface Mtd.	8	17 7/8	5 5/8	8 1/8	18	--	--	--	
5117S21	5127S21	924TDHS		3" Trim	9	23 7/8	5 5/8	12 1/4	27 1/4	10	25	3 1/4	Cosmic & Galaxy 2.5-10, Mercury 2.5-5, Sentinel 5
5119S21	5129S21	924DHS		Surface Mtd.	9	23 7/8	5 5/8	9 1/8	24	--	--	--	

Dimensions in Inches

CORNER VU SERIES: Steel, Stainless Steel and Aluminum Corner-Mount Cabinets

Door and Trim Construction: #4 satin stainless steel, clear anodized aluminum or cold rolled steel with white powder-coat finish standard. Flush cabinet doors with a 5/8" door stop are attached by a continuous hinge and equipped with zinc-plated handle and roller catch.

Trim Style and Depth: This corner-mounted cabinet is designed to be surface-mounted.

Tub: Cold rolled steel with white powder-coat finish standard.

Fire-Rated Option Available: No

Door Styles w/pull

F	Full Glazing
G	Full Glazing with SAF-T-LOK™
D	Horizontal Duo Panel
S21	Solid
L22	Solid with SAF-T-LOK™
V	Vertical Duo
W	Vertical Duo with SAF-T-LOK™

Door Glazing

10	Acrylic
17	Tempered Glass

Options at Additional Cost

- Vertical or Horizontal Lettering - See Page 21
- Futura Embossed "Fire" Handle in Mill, White or Red
- Wall Signs, Labels & Alarms- See Page 20
- Color Anodized Aluminum - See Page 24
- Optional Color Frame/Door/Tub - see Page 24
- Custom Color Frame/Door/Tub
- Engraved Metal or Etched Glass Lettering



CORNER VU
8913F10

Trim and Door Material and Series #				Outer Dimensions			Accommodates Following Extinguishers
Steel	Aluminum	Stainless Steel	Trim Style	W	H	D	
8913	8923	8933	Surf. Mtd.	15 3/4	18	8 1/8	Cosmic & Galaxy 2.5-6, Mercury 2.5-15
8813	8823	8833	Surf. Mtd.	15 3/4	24	8 1/8	Cosmic & Galaxy 2.5-10, Mercury 2.5-15 (FM11C & 15C), Saturn 15, Sentinel 5

Dimensions in Inches

FIRE EXTINGUISHER CABINETS



CANOPY SERIES: Surface-Mounted Aluminum Bubble Cabinet

Door and Trim Construction: All clear anodized aluminum construction. Flush cabinet doors with a 5/8" door stop are attached by a continuous hinge and equipped with aluminum turn knob and roller catch. Extinguisher to be mounted to wall using bracket

Bubble: Acrylic bubble allows 180° extinguisher visibility. Projection - B525-7-1/4", C525 - 8-1/2".

Trim Style and Depth: Aluminum surface-mounted frame with 1" projection. Trim on frame is 1-5/8", door trim is 1-3/8"

Tub: None

Fire-Rated Option Available: No

Bubble

- 25 Clear Acrylic
- 26 Red Acrylic
- 27 Bronze Acrylic

Options at Additional Cost

- Custom Finishes
- White or Bronze Painted Door and Trim
- Wall Signs and Labels. See Page 20
- Vertical or Horizontal Lettering - See Page 21
- Pull Handle



B525F25

Trim and Door Material and Series #	Previous Model #	Projection with Bubble	Frame I.D.		Frame O.D.		Accommodates Following Extinguishers
			W	H	W	H	
B525	SMB-10	7 5/8	12 5/16	28 3/16	15 5/8	31 1/2	Cosmic & Galaxy 2.5-10, any Mercury or Grenadier P, Saturn 15, Sentinel 5-10
C525	SMB-20	9 3/4	15	35 1/2	18 5/16	38 11/16	Any Cosmic, Galaxy, Mercury or Grenadier P, Saturn 15, Sentinel 5-10

Dimensions in Inches

SM SERIES: Economical Surface-Mount Aluminum Cabinet

Construction: All aluminum with white powder coat finish standard. Cabinet is hinged on top and plexiglass front slides in.

Door: Full Breakaway Plexiglass, with center pull handle and tamperproof security screws.

Options: Other colors - see page 24. TSHS Spanner Tool Head Screwdriver. Wall Signs and Labels - see page 21.

Fire-Rated Option: No

Door Styles

- J Center Pull Handle w/ Tamperproof Screws
- G Center Pull Handle w/ Cylinder Lock

Door Glazing

- 30 Clear Plexiglass



SM6773J

Model #	Previous Model #	Depth of Cabinet	Frame O.D.			Glazing Size		Master Pack Number	Accommodates Following Extinguishers
			W	H	Projection	W	H		
6473	SM-5	4 1/2	9	21 1/8	5 7/16	7 7/8	20 1/2	5	Cosmic & Galaxy 2.5-5.5, Mercury 2.5-5
6573	SM-10	5 1/2	9 7/8	24 1/8	6 7/16	9	23 9/16	5	Cosmic & Galaxy 2.5-10, Mercury 2.5-5, Sentinel 5
6773	SM-20	7 13/16	11	28	8 3/4	10 1/4	27 9/16	1	Any Cosmic, Galaxy, Mercury, Saturn or Grenadier P, Sentinel 5
6973	SM-30	9 1/16	14	30	10	13 1/4	29 7/8	1	Any Cosmic, Galaxy, Mercury, Saturn or Grenadier P, Sentinel 5-15, 272

Dimensions in Inches

FB SERIES: FIBERGLASS FIRE EXTINGUISHER CABINET

Construction: Door and tub are UV-resistant fiberglass with high-visibility red finish and 5" x 9" Fire Extinguisher Lettering

Door: Gasketed door with 6" x 9" Gasketed view window and corrosion-resistant aluminum handle. All cabinets come standard with a full-length stainless steel hinge attached by rivets. Door is tightly latched against the silicone gasket by (2) stainless steel snap latches.

Fire-Rated Option: No



Model	Tub Size I.D.			Outside Dimensions			Fire Extinguishers
	W	H	D	W	H	D	
1363D12	12-1/2"	24"	8-1/2"	16"	27"	10.25	Any Cosmic, Galaxy, Mercury, Saturn 15, Grenadier, Sentinel 5-10



SECURITY AND DETENTION CABINETS

JL security and detention cabinets for fire extinguishers, fire hoses or fire department valves are constructed to meet maximum security requirements in areas where fire protection is required. All recessed models have heavy-duty masonry anchors welded to the frame.

Door and Trim: 12 gauge steel with white powder coat finish, or 14 gauge #4 satin stainless finish. Flush cabinet doors are mounted in a 5/8" door stop and attached by a heavy-duty continuous hinge.

Trim Style and Depth: 1-1/4" trim on frame non-rated, 1-1/2" trim on fire-rated frames. Available in Recessed with flat trim, Semi-recessed with 2-1/2" square trim or Surface-mount model with square edge. Heavy duty masonry anchors are welded to frame on all recessed cabinets.

Tub: Steel models have 14 gauge steel with white powder coat primer finish. Stainless steel models have 14 gauge stainless tub.

Fire-Rated Option Available: Yes.

Options At Additional Cost: ADA Flush Pull, Vertical or Horizontal Lettering - Pg. 21, Optional Colors for Steel Cabinets. See Pg 24.

Duo Panel Door with Lexan® Glazing

Lock Options At Additional Cost: Mortise Deadbolt Prep or Prep w/Lock, Mortise Cylinder Prep or Prep w/Lock, Detention Deadlock

Prep or Prep w/Lock, Detention Slam Lock Prep or Prep w/Lock



SFC 15
W/DETECTION DEADBOLT



SSFC-37 W/DETECTION
DEADBOLT



SVC-13 W/OPTIONAL COLOR

TRIM & DO OR MATERIAL & SERIES			TUB I.D.			*FRAME O.D.			WALL OPENING NON-RATED			WALL OPENING FX OPTION			RECOMMENDED EXTINGUISHER, HOSE & RACK
STEEL	STAINLESS	TRIM STYLE	W	H	D	W	H	D	W	H	D	W	H	D	
SECURITY FIRE EXTINGUISHER CABINETS (SFC)															
SFC-11	SSFC-31	Flat Trim	10 1/2	24	6 1/2	12 1/2	26	11 1/2	25	7	12 1/2	26 1/2	7 1/2		Cosmic & Galaxy 2.5-10, Mercury 2.5 & 5**
SFC-12	SSFC-32	2-1/2" Sqr. Trim	10 1/2	24	6 1/2	12-1/2	26	11 1/2	25	4-1/2	12 1/2	26 1/2	5		
SFC-13	SSFC-33	Surface Mt. Sq.	13	26-1/2	8	13	26 1/2	--	--	--	--	--	--		
SFC-15	SSFC-35	Flat Trim	12	27	8 1/2	14	29	13	28	9	14	29 1/2	9 1/2	Cosmic & Galaxy 2.5-20, Mercury 2.5-15, Saturn 5, Sentinel 5**	
SFC-16	SSFC-36	2-1/2" Sqr. Trim	12	27	8 1/2	14	29	13	28	6-1/2	14	29 1/2	7		
SFC-17	SSFC-37	Surface Mt. Sq.	14 1/2	29 1/2	10	14 1/2	29 1/2	--	--	--	--	--	--		
SECURITY VALVE CABINETS (SVC)															
SVC-11	SSVC-31	Flat Trim	18	18	8 1/2	20	20	19	19	9	20	20 1/2	9 1/2	1-1/2" or 2-1/2" Fire Department Valve Knockouts 11 & 31: 2 each side - 5" from top, bottom and back. 12 & 32: 2 each side - 4.5" from top, bottom and back, Not Available on F.R. Cabinets	
SVC-12	SSVC-32	2-1/2" Sqr Trim	18	18	8 1/2	20	20	19	19	6 1/2	20	20 1/2	7		
SVC-13	SSVC-33	Surface Mt. Sq.	20 1/2	20 1/2	10	20 1/2	20 1/2	--	--	--	--	--	--		
SECURITY HOSE CABINETS (SHC)															
SHC-11	SSHC-31	Flat Trim	32 3/4	34 3/4	8	34 3/4	36 3/4	33 3/4	35 3/4	8 1/2	34 3/4	36 3/4	9	1-1/2" or 2-1/2" Hose Rack, & Extinguisher, or Fire Department Valve & Extinguisher Knockouts: 2 each side - 4" from top bottom and back, N/A on F.R. Cabinets	
SHC-12	SSHC-32	2-1/2" Sqr. Trim	32 3/4	34 3/4	8	34 3/4	36 3/4	33 3/4	35 3/4	6	34 3/4	36 3/4	6 1/2		
SHC-13	SSHC-33	Surface Mt. Sq.	36 3/4	38 3/4	8	36 3/4	38 3/4	--	--	--	--	--	--		

Dimensions in Inches

*FIRE RATED CABINETS - ADD 1" TO FRAME OD
**USE JL EXTINGUISHERS ONLY IN THIS CABINET.

SCHOOL CABINETS

Door and Trim: 12 gauge steel or 14 gauge stainless steel door with tempered glass is mounted in a 5/8" door stop, attached by a continuous hinge and equipped with zinc-plated handle.

Trim Style: Recessed - Flat Trim. Surface mount and semi-recessed models have a square edge.

Tub: 16 gauge steel with white powder-coated primer. Stainless steel models have stainless tub. Masonry anchors standard.

Options at Additional Cost: Duo panel door with Lexan® glazing, ADA pull, red powder-coated finish, SAF-T-LOK™, vertical or horizontal lettering in red, white or black - see page 21. Other door styles - contact customer service.

Fire-Rated Option Available: Yes



SCHOOL CABINET
CS2015F17

Model		Tub I.D.			*Frame O.D.		Wall Opening: Non-Rated			Wall Opening: FX Option			Accommodates Following Extinguishers
Steel	Trim Style	W	H	D	W	H	W	H	D	W	H	D	
CS2015F17	Flat Trim	12	27	7 3/4	14	29	13	28	8	14	29	8 3/4	Any Cosmic, Galaxy, Mercury, Saturn & Grenadier P, Sentinel 5-10
CS2017F17	2 1/2 Square	12	27	7 3/4	14	29	13	28	5 1/2	14	29	6 1/2	
CS2013F17	Surf. Mtd.	14 1/2	29 1/2	8	14 1/2	29 1/2	--	--	--	--	--	--	

Dimensions in Inches

*FIRE RATED CABINETS - ADD 1" TO FRAME OD.

EMERGENCY SPECIALTIES



FREESTANDING AED CABINET STAND: 1480 SERIES

This Decorative Stand with a Surface-Mount Steel or Aluminum Cabinet can be an Attractive Addition to a Building's Décor by Coordinating Finishes and Paint Colors.

Construction: 52" structural steel tubing and steel baseplate. White epoxy or silver metallic finish standard, with custom colors also available.



DUAL CABINET FOR AED AND EMERGENCY OXYGEN: OLYMPUS 1900 SERIES

Provide More Lifesaving Equipment by Including Emergency Oxygen with Your AED.

Door & Trim Construction: CRS with white powder-coat finish, #4 stainless steel or clear anodized aluminum. 1-3/4" trim on face and door, mounted in a 5/8" door stop and attached by a continuous hinge. All models feature a clear acrylic window with graphics, zinc-plated handle and roller catch.



1913F12

Trim Style & Depth: Surface-mount has a square edge. Recessed – 3/8" flat trim, Semi-Recessed – 1-1/2" square edge or 3" rolled edge.

Alarm: 85 db Commander (audible) alarm standard.

Oxygen: Accommodates up to "D" size cylinder. Available with patented T⁰2 oxygen system that features easy-to use automatic flow system.

Tub: White powder coated CRS. Fire-rated option available.

WEATHER-RESISTANT AED CABINETS: 1499 SERIES

Protect Your AED From Moisture and Dust with this Durable Surface-Mount Cabinet.

Construction: Molded UV-Inhibited ABS white Korad™ with fully-gasketed door and clear acrylic window with graphics. Includes exterior-grade handle with lockable latch and stainless steel hinges.

AUTOMATED EXTERNAL DEFIBRILLATORS: LS-AED SERIES

All Defibrillators Meet Local and National Standards for Emergency Care in Public Places and are FDA-Approved. JL has Several Models Available Which All Feature Automatic Heartbeat Detection, Require Minimum Training to Operate and Include a Training Video.

AED CABINETS TO FIT MOST BRANDS: 1400 LIFESTART SERIES

Designed to Accommodate Most AED's on the Market Today.

Door & Trim Construction: CRS with white powder-coat finish, #4 stainless steel or clear anodized aluminum. 1-3/4" trim on face. Formed door with 1-3/4" trim, mounted in a 5/8" door stop with zinc-plated handle and roller catch and continuous hinge. View AED through a clear acrylic window with graphics.



1436

Trim Style & Depth: Surface-mount has a square edge. Recessed – 3/8" flat trim, Semi-Recessed – 1-1/2" square edge or 3" rolled edge.

Alarm: 85 db Commander (audible) alarm standard.

Tub: White powder-coated CRS. Fire-rated available.

METAL AED CABINET OPTIONS AND ACCESSORIES

Siren Strobe Alarm and 85 db Alarm for 3" & Surf. Mtd (9V battery) (SA)
Alarm Connectivity Switch: Magnetic Door contact (14MAG) or Roller Reed Contact (14RR).

Saf-T-Clasp for Visual Notification if Door has been Opened (14STC)

Custom Door Graphics

AED Wall Signs

Architectural Bronze or Brass

Custom Sizes & Paint Colors

Fire-Rated Cabinet (FX)

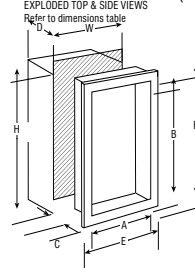

1413SA

Lifestart Series for Any Brand AED

Trim and Door Material and Series #				Tub I.D.			Frame O.D.		Wall Opening Non-Rated			Wall Opening Fire-Rated Option		
Steel	Aluminum	Stainless Steel	Trim Style	A	B	C	E	F	W	H	D	W	H	D
1415	1425	1435	Flat Trim	14"	14"	6 3/4"	17 3/8"	17 3/8"	15 1/4"	15 1/4"	6 1/2"	16 7/8"	16 7/8"	7 5/8"
1416	1426	1436	1 1/2"	14"	14"	6 3/4"	17 3/8"	17 3/8"	15 1/4"	15 1/4"	5 7/8"	16 7/8"	16 7/8"	6 1/2"
1417	1427	1437	3"	14"	14"	6 3/4"	17 3/8"	17 3/8"	15 1/4"	15 1/4"	*3 3/4"	16 7/8"	16 7/8"	* 4 3/4"
1413	1423	1439	Surf. Mtd.	17 3/16"	17 3/16"	7"	17 3/8"	17 3/8"	-	-	-	-	-	-

* Model 1427 has 2-1/2" trim

The New Side-by-Side Olympus Series for AED & Extinguisher or Oxygen

Trim and Door Material and Series #				Tub I.D.			Frame O.D.		Wall Opening Non-Rated			Wall Opening Fire-Rated Option		
Steel	Aluminum	Stainless Steel	Trim Style	W	H	D	E	F	W	H	D	W	H	D
1915	1925	1935	Flat Trim	18"	18"	8"	21 3/8"	21 3/8"	19"	19"	7 3/4"	20"	20 1/8"	8 5/8"
1916	1926	1936	1 1/4"	18"	18"	8"	21 3/8"	21 3/8"	19"	19"	6 7/8"	20"	20 1/8"	7 3/4"
1917	1927	1937	3"	18"	18"	8"	21 3/8"	21 3/8"	19"	19"	5 5/8"	20"	20 1/8"	6 1/2"
1913	1923	1939	Surf. Mtd.	21 3/16"	21 3/16"	8 1/2"	21 3/8"	21 3/8"	-	-	-	-	-	-

DIMENSIONS IN INCHES

FIRE HOSE AND EQUIPMENT CABINETS



FIRE HOSE EQUIPMENT CABINET

This durable Storage Cabinet has CRS Steel or Galvanized Steel Construction for Interior or Exterior Use. The top is angled with a 3" overhang to shed water.

Construction: 16 gauge galvanized or cold rolled steel construction. Both are finished with red powder-coat paint and feature removeable, adjustable shelf and louvers on both sides of cabinet for ventilation. Top is slightly angled and overhangs the doors by 2-7/8". Optional legs are CRS.

Hardware: Hasp for a padlock (by others) standard.

Size: 58" W x 42" H x 18 1/2" D

Options: DFFH or 1403 "Fire Hose" Decal, Locking chrome handle with top & bottom latching. (must be ordered with cabinet in order to install rod latching system)

Models:

HECIG: Galvanized

HECIGL: Galvanized with Legs

HECIR: Steel

HECIRL: Steel with Legs

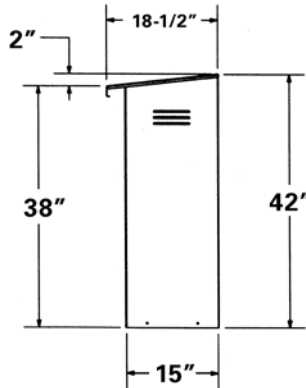

HECIGL OR HECIRL



HECIG OR HECIR

3000, 3100 AND 3200 SERIES: Fire Hose Rack Assembly

Operation: One-man operation for immediate means of fire control.

Ratings: 100 GPM at 65 PSI at the nozzle. Hose is FM-approved, Industrial Fog Nozzle, Angle Valve and Pin Rack are UL-rated. Models 3005-3110 rated for Class II Service under NFPA/FEMA Class of service. Models 3205-3212 rated for Class II and Class III Service under NFPA/FEMA Class of service.

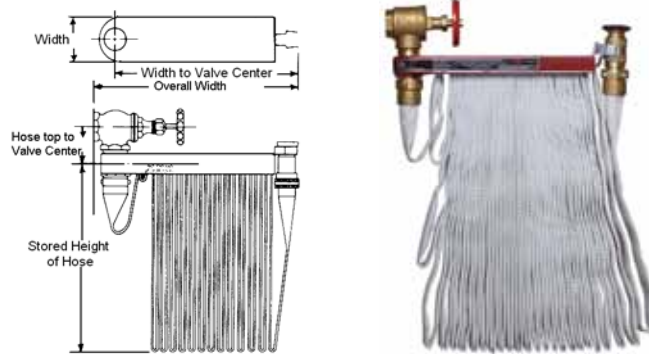

Model #	Hose Length	Hose Diameter	Hose Type	Valve Size	Rack Length	Class of Service	Stored Height of Hose	Width of Rack	Height from Hose Top to Valve Center	Overall Width of Stored Unit to Valve Center
Basic Unit For 1 1/2" Hose and Valve with Single Jacket Lined Hose, Industrial Fog Nozzle, Red Enamel Pin Rack and Cast Brass Coupling, Angle Valve, Escutcheon and Nipple										
3005	50'	1 1/2"	Poly Lined Hose	1 1/2"	17 7/8	II	23	4 1/8	3 7/8	19 3/4
3007	75'	1 1/2"		1 1/2"	17 7/8	II	23	4 1/8	3 7/8	19 3/4
3010	100'	1 1/2"		1 1/2"	17 7/8	II	23	4 1/8	3 7/8	19 3/4
Basic Unit Above, with Red Enamel Rack, Chrome-plated Brass Fittings and Chrome-plated Rough Brass Valve										
3105	50'	1 1/2"	Poly Lined Hose	1 1/2"	17 7/8	II	23	4 1/8	3 7/8	19 3/4
3107	75'	1 1/2"		1 1/2"	17 7/8	II	23	4 1/8	3 7/8	19 3/4
3110	100'	1 1/2"		1 1/2"	17 7/8	II	23	4 1/8	3 7/8	19 3/4
Basic Unit For 1 1/2" Hose and 2 1/2" Valve with Single Jacket Lined Hose, Industrial Fog Nozzle, Red Enamel Pin Rack and Cast Brass Coupling, Angle Valve, Reducer, Escutcheon and Nipple										
3205	50'	1 1/2"	Poly Lined Hose	2 1/2"	17 7/8	II and III	23	4 1/8	4 1/8	20 1/16
3207	75'	1 1/2"		2 1/2"	17 7/8	II and III	23	4 1/8	4 1/8	20 1/16
3210	100'	1 1/2"		2 1/2"	17 7/8	II and III	25	4 1/8	4 1/8	20 1/16
3212	125'	1 1/2"		2 1/2"	17 7/8	II and III	28	4 1/8	4 1/8	20 1/16
SEE CROWLINE SERIES FOR CABINETS TO FIT FIRE HOSE RACK ASSEMBLIES										
Dimensions in Inches										

FIRE HOSE AND VALVE CABINETS

CROWNLINE 6000-7200 SERIES: Cabinets for Fire Hoses and Extinguishers CROWNLINE 8000 SERIES: Cabinets for Fire Department Valves

Door and Trim: #4 stainless steel, clear anodized aluminum or cold rolled steel with white powder-coat finish standard. 1 3/4" Trim on face and door. These flush cabinet doors are mounted in a 5/8" door stop are attached by a continuous hinge and equipped with zinc-plated handle and roller catch for all non-break glazed doors.

Trim Style and Depth: Recessed - 3/8" flat trim or trimless (install before wallboard). Semi-Recessed - 1 1/4" Square Edge or 2 1/2" Rolled Edge. Surface-mount has a square edge or optional rolled edge for steel upon request, stainless models have rolled edge. 1 3/4" face trim on frame and door.

Tube: White powder-coated cold rolled steel. Surface-mounted stainless steel models feature a galvanized back panel.

Fire-Rated Option Available: Yes



6517V10
SHOWN IN OPTIONAL RED FINISH



6337F10



6325A10
WITH SAF-T-LOK™



6514B10FX
WITH SAF-T-LOK™



8016F10

Door Styles with Pull

- F Full Glazing
- G Full Glazing & Saf-t-Lok™
- D Horizontal Duo Panel
- E Horizontal Duo Panel & Saf-T-Lok™
- S21 Solid
- L22 Solid with SAF-T-LOK™
- L24 Solid with Cylinder Lock & No Handle
- B10 Solid with Acrylic Insert & Saf-T-Lok™
- V Vertical Duo
- W Vertical Duo & Saf-T-Lok™
- A Center Duo Panel with Saf-T-Lok™

Door Glazing

- 10 Clear Acrylic
- 13 Clear Wire Glass
- 15 Bronze Acrylic
- 16 Gray Acrylic
- 17 Tempered Glass
- 18 Laminated Safety Glass

Options at Additional Cost

- Aluminum Tub for Non-Rated Use
- Vertical or Horizontal Lettering - Pg 21
- Futura Embossed "Fire" Handle in Mill, White or Red
- ADA Flush Pull
- Fire-FX® Fire-Rated Tub Option
- Stainless Steel Tub #4 Satin Finish (Knockouts not available)
- Wall Signs & Labels - Pg 21
- Color Anodized Aluminum - Pg 24
- Optional Standard Color Frame/Door/Tub - Pg 21
- Custom Color Frame/Door/Tub - Pg 24
- Alarms - Pg 20
- Engraved Metal or Etched Glass Lettering Pg. 21
- Break Glass Hammer & Chain
- Custom Stainless Finishes # 6 Satin, #7 Polished, #8 Mirror
- Brass or Bronze Finishes - See Embassy Series Pg. 10
- 12 Gauge Security Cabinets - See Pg. 15

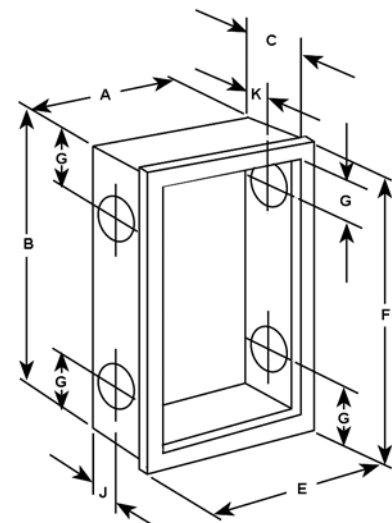
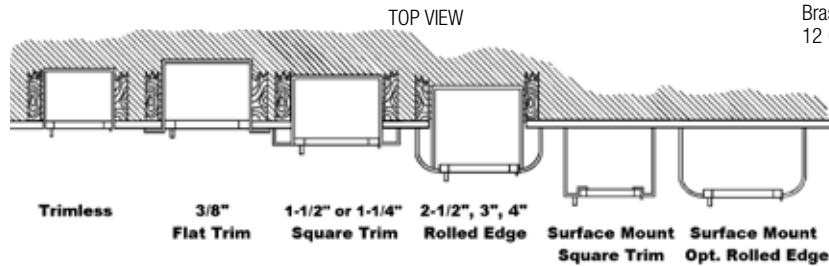

Knockouts: Hose Cabinet Knockouts for Recessed and Semi-Recessed Models:

Knockouts (K.O.s) are provided centered, one, side, top and bottom—other side offset, top and bottom. Cabinets with 6" depth will have K.O.'s centered. Trimless K.O.s centered only—no offset. For surface-mount cabinets knockouts are provided only when exact location is known.

K.O.s are not provided on FIRE-FX cabinets or stainless tubs. Instructions for the knockouts in the field are provided and must be strictly adhered to maintain fire-rating.

FIRE BLANKETS & ACCESSORIES

LOCKS & LOCK BOXES

PULLS



ALARMS

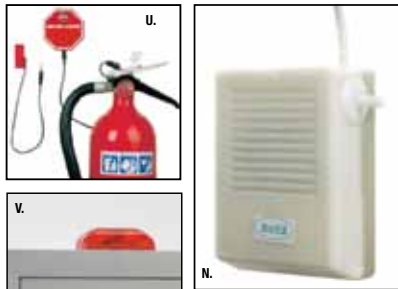

N. COMMANDER ALARM
Easy to install cabinet alarms protect against theft or tampering. The Commander Alarm (shown here) is an economical choice.



ACCESSORIES

- A. Security lock box 4" x 6" x 2 1/2"
- B. Security lock box alarm cover 6" x 6" x 21/2"
- C. LBLA16 lockbox L.A.F.D. with red decal, 16 gauge, 5" x 5" x 1 1/2" approved lockbox for L.A. county
- D. Keyed-alike Abus padlock
- E. Samson brass keyed-alike padlock
- F. Break glass lock lever assembly LL24-KIT
- G. Fire department lock box 4" x 6" x 1 1/2"
- H. Breaker bar with chain
- L. Futura "FIRE" handle
- M. ADAC flush pull handle
- N. Commander Alarm
- O. Standard zinc pull (PUS)
- P. Chrome pull
- Q. US10B pull
- R. Bronze pull
- S. Brass pull
- T. Lever Handle
- U. Brigadier alarm (BA)
- V. Strobe alarm (SA)

FIRE BLANKETS AND CABINETS

Fire Blankets & Cabinet: Royal fire blanket cabinets come in two basic designs. The Royal **9519S21** is a roller type for emergency use. The enclosed blanket is attached to the vertical roller and comes with arm loops to enable a person to wrap themselves in the blanket in one continuous motion. The Royal **9613S21** is a handy "drop" type with folded blanket. Both units are surface mounted. Each comes with a nominal 62" x 84", 3 1/2 pound, processed wool fire blanket, which meets the Flammable Fabrics Act: Flammability of Clothing Textiles, Title 16, CFR1610.



9519S21

Blanket & Extinguisher Combination Cabinet

Door & Trim Construction: CRS with white powder-coat finish, clear anodized aluminum or #4 stainless steel. Flush cabinet doors with a 5/8" door stop are attached by a continuous hinge and equipped with zinc-plated handle and roller catch. Full glass front with pull handle.

Trim Style & Depth: Recessed - 3/8" flat trim, Semi-recessed - 1-1/2" square trim, 2-1/2", 4" or 4-1/2" rolled edge, Surface-Mounted - square edge. 1-3/4" face trim on frame and doors.

Tub: CRS with white powder coat finish standard. Surface-mounted models have clear anodized aluminum tubs.

Glazing: Full front glazing .09 Acrylic.

Shelf: Shelf is located 9" from the top of the cabinet, providing storage of the blanket above the extinguisher.

Blanket: Each cabinet includes a nominal 62" x 84" x 3-1/2 lb, processed wool fire blanket which meets the Flammable Fabrics Act: Flammability of Clothing Textiles, Title 16, CFR21610.

Fire Rated Option Available: Yes
Options at Additional Cost:

- SAF-T-LOK™
- ADAC Flush Pull
- Futura "Fire" Handle in Red, White or Mill
- Lettering in Black or Red Pg. 21
- Color Painted Tub - Red or Black
- Color Painted Trim and Door Red or Black
- Color Anodizing for Aluminum Finishes Pg. 24
- Wall Signs, Labels & Alarms pg. 20-21



3616F10

TRIM & DOOR & SERIES #			TUB I.D.			FRAME O.D.			Wall Opening: Non-Rated			Wall Opening: Fire-Rated			ACCOMMODATES FOLLOWING EXTINGUISHERS
Steel	Aluminum	Stainless	Trim Style	W	H	D	W	H	D	W	H	D	W	H	
3615	3625	3635	Flat Trim	12"	36"	8"	15-3/8"	39-3/8"	13"	37"	8"	14"	38"	9"	Cosmic & Galaxy 2.5-10, Mercury 2.5-15 (FM11C & 15C), Sentinel 5
3616	3626	3636	1-1/2" Square	12"	36"	8"	15-3/8"	39-3/8"	13"	37"	6-3/4"	14"	38"	7-1/2"	
3617	3627*	3637	2-1/2" Rolled	12"	36"	8"	15-3/8"	39-3/8"	13"	37"	5-3/4"	14"	38"	6-1/2**	
3612	3622	3632	4" Rolled	12"	36"	8"	15-3/8"	39-3/8"	13"	37"	4-1/4"	14"	38"	5"	
3618	3628	3638	4-1/2" Rolled	12"	36"	8"	15-3/8"	39-3/8"	13"	37"	3-3/4"	14"	38"	4-1/2"	
3613	3623	3633	Surface-Mtd.	15-3/16	39-3/16	8"	15-3/8"	39-3/8"	---	---	---	---	---	---	

*Add 5/8 to depth needed for this cabinet in aluminum.



DECALS AND DIE CUT LETTERING

DECALS		DIE CUT LETTERING & SIGNS	
1	Decal: 4" x 4" - red & white, WARNING #DRWF	16	Diecut: 3/4" x 18" - vertical, red, FIRE EXT #LDCVRF
2	Decal: 4" x 8 3/4" - horizontal, black & red, FIRE HOSE #DFFH	16R	Diecut: 3/4" x 18" - vertical, red, in reverse FIRE EXT #LDCVRRFE
3	Decal: 2 1/4" x 4" - horizontal, black & red, BREAK GLASS #DRBGR	17	Diecut: 3/4" x 18" - vertical, white, FIRE EXT#LDCVWFE
4	Decal: 1 1/4" x 4" - horizontal, red & white, FIRE EXT. #DWFE	17R	Diecut: 3/4" x 18" - vertical, white, FIRE EXT in reverse #LDCVWRF
5	Decal: 3" x 4" - horizontal, black & red, FIRE EXT. #DRFER	18	Diecut: 3/4" x 18" - vertical, black, FIRE EXT #LDCVBF
6	Decal: 11 3/4" x 3 1/2" - vertical, red & white, FIRE EXT. #DRFA	18R	Diecut: 3/4" x 18" - vertical, black, in reverse FIRE EXT#LDCVBRFE
7	Decal: 1" x 4 1/4" - vertical, red & white, IN CASE OF FIRE #PHCD-RED	19	Diecut: 2 1/4" x 7 3/4" - horizontal, red, FIRE EXT#LDCHRFE
8	Decal: 6" x 6" - octagonal, red, black & white, F.D. VALVE #FDVO	20	Diecut: 2 1/4" x 7 3/4" - horizontal, white, FIRE EXT#LDCHWFE
9	Decal: 4" x 9" - horizontal, black & red, FIRE HOSE #1403	21	Diecut: 2 1/4" x 7 3/4" - horizontal, black, FIRE EXT#LDCHBFE
10	Decal: 7 1/8" x 2 1/4" - horizontal, red & white, FIRE EXT. #LDHRFE	22	Plastic sign: 4" x 12" 3D angle FIRE EXTINGUISHER #22S
11	Decal: 7 1/8" x 2 1/4" - horizontal, FIRE EXT. #LDHWFE	23	Plastic sign: 4" x 18" 3D tent FIRE EXTINGUISHER #23S
12	Decal: 7 1/8" x 2 1/4" - horizontal, black & white, FIRE EXT. #LDHBFE	24	Plastic sign: 5" x 6" 3D tent FIRE EXTINGUISHER #24S
13	Decal: 2" x 19" - vertical, red/clear FIRE EXT. #LDVRF	25	Plastic sign: 4" x 12" flush vertical FIRE EXT #25S
14	Decal: 2" x 19" - vertical white/clear FIRE EXT. #LDVWFE	26	Diecut: 7 7/8" x 1" - horizontal, red, FIRE BLANKET #DCHRFB
15	Decal: 2" x 19" - vertical black/clear FIRE EXT. #LDVBF	27	Diecut: 10 1/4" x 4 3/8" - horizontal, red FD VALVE #DCHFDV-R
28. Etched lettering in glass or engraved lettering in metal. Available with optional color fill as shown above.			



Advocate Lutheran General Hospital – Park Ridge, IL
American Embassy – Kathmandu Nepal
Amsterdam Airport Schipol - Netherlands
Anaheim Convention Center - Anaheim, CA
Baltimore Hilton – Convention Center – Baltimore MD
Caesar's Palace Forum Ship - Las Vegas, NV
California Adventure - Ultra Flight - Anaheim, CA
City Place Complex - Hollywood, FL
Disney Animal Kingdom Resort - Orlando, FL
Disney Art of Animation Resort - Orlando, FL
Disney Aulani Hotel - Oahu, HI
Disney's All-Star Resort - Anaheim, CA
Federal Courthouse - Boston, MA
First of America Corporation - Kalamazoo, MI
First Union Operations Bldg Soka Univ.- Los Angeles, CA
Georgia State University – Atlanta, GA
Gulf Place - Fort Walton Beach, FL
Hazeltine National Golf Club Clubhouse – Chaska, MN
Hazelton Prison Bruceton Mills, WV
Highwoods Preserve - Tampa, FL
John F. Kennedy Airport - Queens, NY
Johns Hopkins Clinical Building – Baltimore, MD

Lexington On The Green - Lithonia, GA
McCarran Airport – Las Vegas, NV
Maryland Live Casino - Arundel Mills, MD
Medtronic Headquarters Campus - Mounds View, MN
Miami Dade Homestead Motor Sports Complex - Homestead, FL
Minnesota Correctional Facilities - Faribault and Sandstone, MN
Nationals Park (Washington Nationals) – Washington DC
Nissan North America Headquarters - Franklin, TN
Premier Automotive Group - Irvine, CA
Red Sox Spring Training Facility - Fort Meyers, FL
Regatta At Vanderbilt Beach - Naples, FL
Singapore Changi Airport - Singapore
Sportsplex/Natatorium - Laurel, MS
St.Jude Medical Center Addition - Memphis, TN
Target Field – Minneapolis MN
TD Ameritrade Park – Omaha NE
TCF Bank Stadium, University of Minnesota – Minneapolis, MN
The Pentagon – Washington, DC
UCLA Medical Center – Los Angeles, CA
University of California - Irvine, CA
University of Florida Student Union Building - Orlando, FL
Whitehead Research Facility, Emory University - Fort Stewart, GA
Willowbrook Hospital – Cumberland, MD



**HAZELTINE NATIONAL CLUBHOUSE
CAVALIER BRONZE FLAT TRIM & ROLLED EDGE
CABINETS**

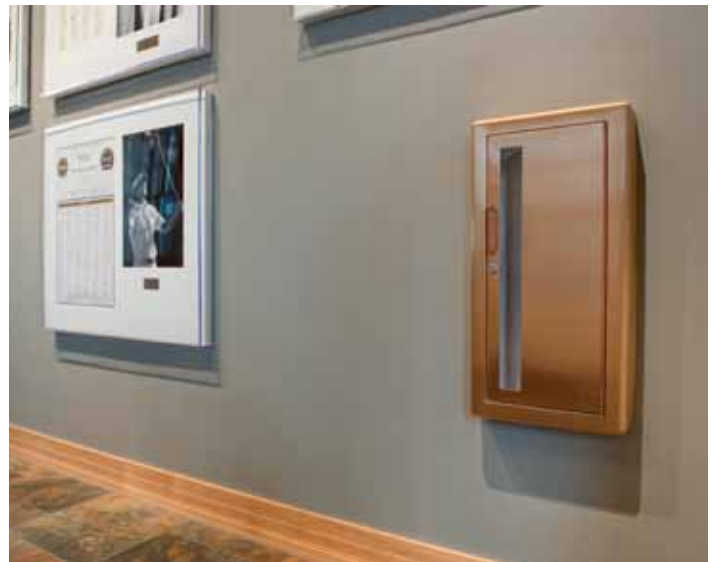



KEY TO CABINET NUMBER SYSTEM

Recessed Tub Size (I.D.)		Door/Trim Material		Trim Depth	
15	10 1/2 x 24 x 4	1	Steel, white primer finish	2	Semi-Recessed 4" rolled edge (ADAC flush pull)
17	10-1/2 x 24 x 5	2	Aluminum, #180 clear satin anodized finish	3	Surface Mount (4", 6", 8" or 9"), square edge for steel and aluminum
18	10 1/2 x 24 x 5 1/2	3	Stainless Steel, #4 satin finish	4	Trimless (install before wallboard)
10 & 12	10 1/2 x 24 x 6	4	Bronze, US 10 satin clear coated finish	5	Full recessed 3/8", square edge
11	9 x 18 x 4 11/16	5	Brass, US 3 polished coated finish	6	Semi-recessed 1 1/4", 1 1/2", square edge
20	12 x 27 x 7 3/4	7	US4 Satin Brass (priced on application)	7	Semi-recessed 2 1/2" or 3" rolled edge
25	14 x 30 x 4	8	US10B Oil-rubbed Bronze (priced on application)	8	Semi-recessed 4 1/2", rolled edge
30	16 x 32 x 7 3/4	9	Color Anodizing on Aluminum (priced on application)	9	Surface mount 4", 6", 8" or 9" rolled edge for stainless steel or steel. (May be a special order item)
36	12 x 36 x 8	Note: Bronze and brass are not available in 40, 45, or 58 tub sizes. Special materials and finishes are available. Contact JL with your special requirements.		Note: Bronze and brass are not available in # 8, 9 or 2 trim depths.	
40	20 x 27 x 7 3/4				
45	28 x 30 x 4				
55	18 x 18 x 7-3/4				
56	10 1/2 x 24 x 5 3/8				
57	16 x 32 x 7 3/4				
58	32 x 32 x 7-3/4				
59	16 x 40 x 8-3/4				
60	24 x 30 x 6				
61	24 x 30 x 8				
62	24 x 34 3/4 x 6				
63	30 x 30 x 8				
64	24 x 34 3/4 x 8				
65	32 3/4 x 34 3/4 x 8				
66	24 x 38 3/4 x 8				
72	32 3/4 x 38 3/4 x 8				
80	16 x 40 x 9				
81	9 x 18 x 5 1/2				
84	18 x 18 x 10				
85	18 x 18 x 8				
86	26 x 26 x 10				
87	26 x 26 x 8				

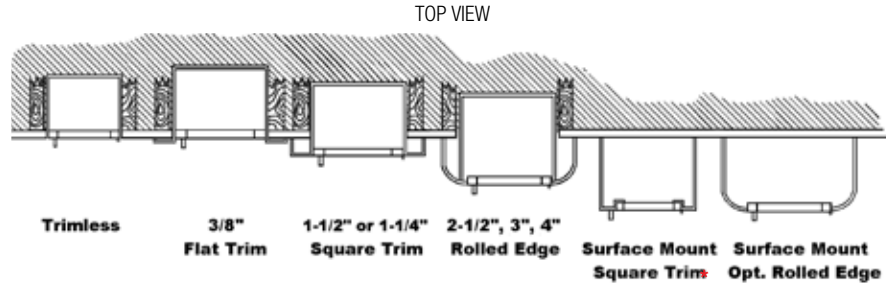

***Note:** For surface mount cabinets, add 3 3/16" to width and height measurements. See product page for wall opening dimensions

Door Style		Door Glazing	
B10	Solid with acrylic insert and SAF-T-LOK™ with pull handle	10	Clear acrylic
D	Duo panel with pull handle	13	Clear wire
E	Duo panel with SAF-T-LOK™ with pull handle	15	1/4" bronze acrylic
F	Full glass with pull handle	16	1/4" gray acrylic
G	Full glass with SAF-T-LOK™ with pull handle	17	Clear tempered glass
L22	Solid with lock, no glazing and pull handle	18	Clear safety glass
S21	Solid with pull handle, no glazing (except Embassy)	25	Clear Bubble - Clear Vu, SMB, RBC
L24	Solid with cylinder lock & no pull handle	26	Red Bubble - Clear Vu, SMB, RBC
V	Vertical Duo Panel with pull handle (except Embassy)	27	Bronze Bubble - Clear Vu, SMB, RBC
W	Vertical Duo Panel with SAF-T-LOK™ with pull handle		
Panorama Door Styles Below		Panorama Glazing Styles Below	
P	Colored acrylic for Panorama, with pull handle	40	3/16" Black acrylic with white "V" letter
Q	Colored acrylic for Panorama, with SAF-T-LOK™	41	3/16" Red acrylic with white "V" letter
		42	3/16" White acrylic with black "V" letter
		43	3/16" White acrylic with red "V" letter
		45	3/16" Black acrylic with white "H" letter
		46	3/16" Red acrylic with white "H" letter
		47	3/16" White acrylic with black "H" letter
		48	3/16" White acrylic with red "H" letter
		50	3/16" Black acrylic with white "A" letter
		51	3/16" Red acrylic with white "A" letter
		52	3/16" White acrylic with black "A" letter
		53	3/16" White acrylic with red "A" letter
C	Clear acrylic for Panorama, frameless	70	Clear 3/16" acrylic with pull handle
		71	Clear 3/16" acrylic with SAF-T-LOK™

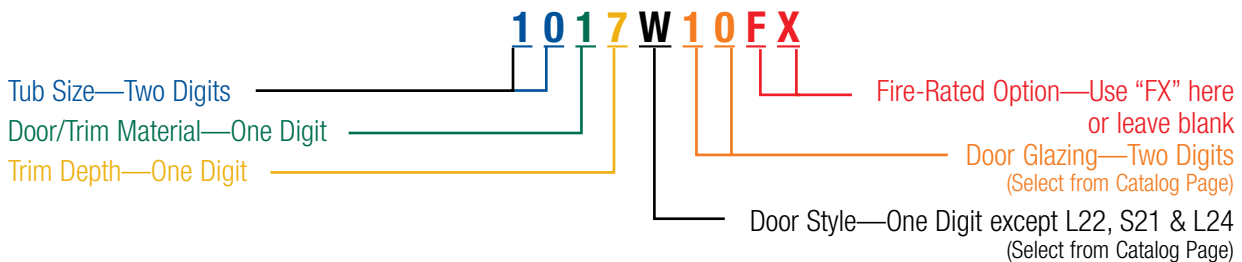

OPTIONAL METAL FINISHES



OPTIONAL POWDERCOAT PAINT COLORS

RED (R)	BLACK (BK)	BRONZE (B)	BRASS (BRA)	SAND (S)	SC BEIGE (SB)	LIGHT ANODIZED
SATIN ALUMINUM (SA)	GRAY HAMMERTONE (GH)	WHITE (W)	AMS BEIGE (AB)	ORANGE (O)	SAFETY YELLOW (Y)	MEDIUM ANODIZED

PLEASE REFER TO PRODUCT PAGE TO SEE WHICH COLOR OPTIONS ARE AVAILABLE



DARK ANODIZED

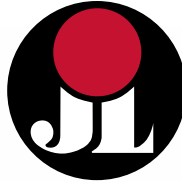

JL INDUSTRIES



MANUFACTURING/WAREHOUSING LOCATIONS



ACPG NORTHWEST WAREHOUSE
RENTON, WA

ACPG HEADQUARTERS
JL INDUSTRIES
4450 W. 78TH STREET CIRCLE, BLOOMINGTON, MN 55435

ACPG CHICAGO WAREHOUSE
WOOD DALE, ILLINOIS

ACPG EAST COAST WAREHOUSE
LANCASTER, PENNSYLVANIA

ACPG WEST COAST
SAMSON PRODUCTS
6285 RANDOLPH STREET, COMMERCE, CA 90040

ACPG SOUTH WAREHOUSE
DALLAS, TEXAS

ACPG ATLANTA WAREHOUSE
ATLANTA, GEORGIA

ACPG SOUTHEAST
THOMAS ENTERPRISES
5765 CORPORATION CIRCLE, FORT MYERS, FL 33905

**CONTACT US: 800-554-6077 FAX: 952-835-2218
SALES@JLINDUSTRIES.COM**

The Activar Construction Products Group (ACPG) is a dynamic group of 5 companies that combine resources, innovation and experience to serve the commercial construction industry. For over 60 years, JL Industries, Samson Products and Thomas Enterprises have manufactured and distributed some of the leading lines of fire protection products including a full line of fire extinguishers and cabinets, AEDs and cabinets plus valve and hose cabinets. They also offer rated and non-rated access panels, roof accessories, corner guards, detention products and entrance floor mats & gratings. Air Louvers offers a wide variety of metal vision lites & louvers, specialized glass, astragals, and metal edging for both wood and hollow metal doors. Hiawatha Inc. has provided high-quality architectural door hardware and components for over 50 years. We now have 5 warehouses with next day shipping in Chicago IL; Lancaster, PA; Dallas, TX; Atlanta, GA; and Seattle WA. Our three manufacturing locations in California and Minnesota and Florida also offer a full range of products, custom manufacturing and quick ship programs for our most popular products.

SUBMITTALS AVAILABLE AT: JLINDUSTRIES.COM

FP1204 REV F